

编号 - - 2018

110115-2018-543H

中芯国际集成电路制造
(北京)有限公司
突发环境事件应急预案
(2018)



发布令

为了加强我公司环境安全生产应急管理工作，完善突发环境事件应急工作，提高突发环境事件应急救援能力，减少人员伤亡和财产损失，根据国家相关法律法规和《企业事业单位突发环境事件应急预案备案管理办法（试行）》，按照各级政府和集团要求，结合公司实际制定了公司突发环境事件应急综合预案、专项预案和现场处置卡，现予以发布实施，请各有关部门认真组织学习，严格贯彻执行。

批准人：



发布日期：2018年12月8日

	1
	7
1.1	7
1.2	7
1.2.1	7
1.2.2	8
1.2.3	8
1.3	8
1.3.1	8
1.3.2	9
1.4	11
1.5	11
	12
2.1	12
2.2	14
2.2.1	14
2.2.2	21
2.2.3	" " 	24
2.2.4	26
2.3	26
2.3.1	26
2.3.2	28
2.4	29
	33
3.1	33
3.1.1	33
3.1.2	33
3.1.3	36
3.1.4	37
3.1.5	37
3.1.6	38
3.1.7	39
3.2	41
3.3	42
3.3.1	42
3.3.2	43
3.4	44
3.5	48
3.5.1	48
3.5.2	50
3.6	53
3.7	53

3.7.1	53
3.7.2	54
3.7.3	54
	55
4.1	55
4.1.1	55
4.1.2	(Q)	55
4.1.3	M	55
4.1.4	E	55
4.1.5	56
4.1.6	56
4.2	57
4.2.1	57
4.2.2	(Q)	57
4.2.3	M	57
4.2.4	E	57
4.2.5	58
4.2.6	58
4.3	58
	59
5.1	59
5.1.1	59
5.1.2	61
5.1.3	62
5.2	ERC	64
5.3	64
5.3.1	64
5.3.2	ERC	69
5.3.3	77
5.3.4	79
5.3.5	86
	87
6.1	87
6.1.1	87
6.1.2	89
6.2	90
6.3	92
	93
7.1	93
7.1.1	93
7.1.2	95
7.1.3	96
7.1.4	98
7.1.5	100

7.1.6	101
7.1.7	104
7.1.8	106
7.1.9	108
7.1.10	109
7.3	109
7.3.1	109
7.3.2	110
7.3.3	114
7.3.4	114
7.3.5	115
7.3.6	116
7.3.7	117
7.3.8	117
7.4	117
7.4.1	117
7.4.2	120
7.4.3	121
7.4.4	123
7.5	125
7.6	125
7.7	126
	127
8.1	127
8.2	130
8.2.1	130
8.2.2	132
8.2.3	133
8.2.4	134
8.2.5	139
8.2.6	141
8.2.7	142
	143
	147
10.1	147
10.2	147
10.3	147
10.4	148
10.4.1	148
10.4.2	148
10.4.3	148
	150
11.1	150
11.2	150

	152
12.1	152
12.2	152
	153
	154
	

1.1

2015

2018

1.2

1.2.1

1.2.2

2004

2015)7

2017

2018

(

[2018]8

1.2.3

1.3

1.3.1

1.3.2

1-3-1

1-3-1

<p>(1) 30 ()100 ; (2) 5 1000 ; (3)</p> <p>(4) ; (5) 1 2 ; (6) (7) ; () (8) ()</p>	<p>(1) 10 30 ()50 100 ; (2) (3) ; 1 5 (4)1 2 ; (5)</p>	<p>(1) 3 10 ()10 50 ; (2) ; (3)3</p>	<p>(1) 3 ()10 ; (2) ; (3)4 5 ; " " " "</p>	
--	---	---	---	--

1-3-1

1	
2	(<5)
3	10 ()

4	() ,
1	
2	, 1
3	, 1 ()
4	() ,
1	() (<20)
2	2
3	()
4	() () ,
1	3 1
2	10 2
3	10
4	6 ,

1.4

" " " " "

"

1.5

1

2

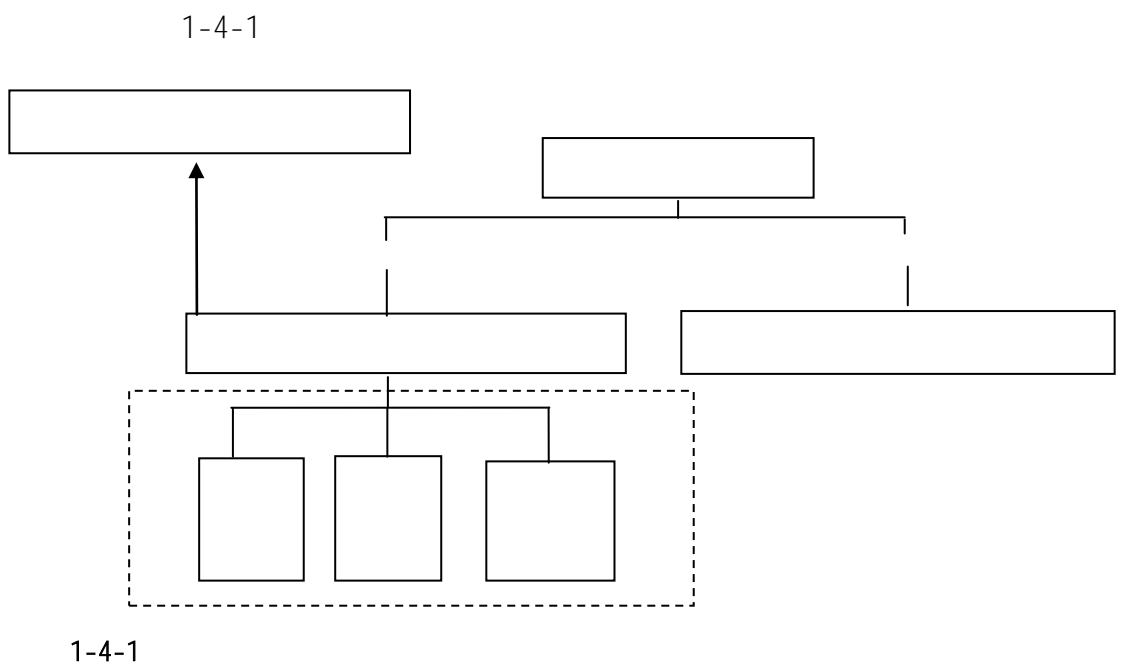

2.1

International Corporation " " Semi conductor Manufacturing

2002 182 63 2004 3 17 18 8000

12 2004 9 12 5.0 / 2-1-1 1

2-1-1

	18			
	18911229252		67855572	100176
	18			
()	136753			3973

1

18

116.50 , 39.78

2

3

2

()

FAB2-P1A

FAB2-P1B FAB2-P1C B01 CUB PS2 CW2

4

3

1

DN500

2 DN150

1984 m³/d

6200 m³/d

2569 m³/d

2

2014

A-0

180m³/d

NH₃-N

45mg/L

"

"

pH

4 UPS

110kV

(CUB)

67782KW

6 1750 KW

4

2500

1700

800

VOC

360

2

12 2

2

5

12

6

8

3 / 12 3 /

8

12 2 /

12 5 /

12 4.3 /

12 5.0

/

2.2

2.2.1

12

2-2-1

0

2-2-2

2-2-1

	SLoc					2017		(T)
	G004	16			59	175	1.086KG/	0.064074
	G003	2			3	8	6.58KG/	0.01974
	G004	7			21	55	4.28KG/	0.08988
	G004	6			10	28	4.28KG/	0.0428
	G001	1			1	0	10.4KG/	0.0104
	G003	2			3	9	1.086KG/	0.003258
	G003	5			11	24	50KG/	0.55
	G003	9			13	25	40KG/	0.52
	G003	2			5	14	10KG/	0.05
	G004	48			115	295	30KG/	3.45
	G001	7			12	39		

	G001	9			9	29	1.3KG/	0.0117
	G004	8			47	122		

/	G001	4			6	20	1.086KG/	0.006516
	G003	5			12	32	5.84KG/	0.07008
	G004	28			69	192	4.27KG/	0.29463
	G003	15			3	23	6.7KG/	0.0201
	G001	1			2	7	130KG/	0.26
	G001	5			17	59	4.4KG/	0.0748
	G001	4			4	50	18.14KG/	0.07256
	G001	9			13	31	22KG/	0.286
	G001	1			4	12	12KG/	0.048
	G001	1			2	3	25KG/	0.05
	C002	100			440	184	350KG/	154
	C004	160			160	240	212KG/	33.92
	C003	60			440	171	164KG/	72.16
	C001	20			20	596	147KG/	2.94
	C002	72			320	1040	200KG/	64
	C002	1			1	1	500mL/	0.5
	C002	76			358	1147	223KG/	79.834
	C006	48			331	946	300KG/	99.3
BOE130: 1	C002	76			129	388	200KG/	25.8
N- NMP	C001	8			46	124	210KG/	9.66
	C002	24			91	276	280KG/	25.48
	C002	76			80	1120	270KG/	21.6
	C001	143			227	659	4KG/	0.908
	C002	141			239	688	200KG/	47.8
BTA	C003	19			18	49	200KG/	3.6

	C003	44			133	431	225KG/	29.925
	C002	1			2	5	206KG/	0.412
	C003	4			14	32	230KG/	3.22
	C002	60			513	1599	220KG/	112.86
	C002	47			51	156	4KG/	0.204
	C002	245			303	878	4KG/	1.212
	C003	68			72	52	500mL/	36L
F	C003	180			180	90	100mL/	18L
	C002	42			92	300	5L/	460L
	C003	170			120	280	10g/	0.0012
	C003	24			24	0	10g/	0.00024
	C003	20			57	191	220KG/	12.54
	C003	70			135	456	55GAL/	7425GAL
	C003	8			16	32	200L/	3200L
	C002	25			25	0	11L/	275L
	C001	5			13	37	200KG/	2.6
	C001	7			11	32	17.7KG/	0.1947
	C001	3			8	23	180KG/	1.44
	C001	6			6	15	2.2KG/	0.0132
	C001	13			16	67	1.5L/	24
	C001	4			5	9	205KG/	1.025
DEV	C003	112			947	2776	200L/	189400L
	C001	128			1607	4720	200L/	321400L
	C001	116			205	636	1GAL/	205GAL
HMDS	C001	71			350	1002	3.785KG/	1.32475

2-2-2

Q

	SLoc				(T)		Q
	G003	2			0.01974	0.5	0.03948
	G001	1			0.0104	10	0.00104
	G003	5			0.55	2.5	0.22
	G002	22			1.2	1	1.2
	G001	104			0.624	7.5	0.0832
	G003	13			0.65	2.5	0.26
	G001	2			0.06	2.5	0.024
	G001	9			0.0117	0.5	0.0234
	G001	6			0.3	5	0.06
	G001	2			0.681	5	0.1362
	G001	3			0.00268	2.5	0.001072
	G001	1			0.007375	2.5	0.00295
	G001	33			0.00364	2.5	0.001456
	G002	6			0.0188	1	0.0188
	G002	18			0.00858	1	0.00858
	G002	18			0.00289	1	0.00289
	G001	5			0.185	5	0.037
	G003	5			0.07008	0.5	0.14016
	G001	1			0.26	10	0.026
	G001	5			0.0748	1	0.0748
	G001	4			0.07256	10	0.007256
	C002	100			154	10	15.4

	C003	60			72.16	10	7.216
	C001	20			2.94	10	0.294
	C002	72			64	1	64
	C002	1			0.5	1	0.000575
	C002	76			79.834	7.5	10.644533
	C006	48			99.3	10	9.93
	C002	76			21.6	7.5	2.88
	C001	13			24	5	0.0059232
	C001	4			1.025	5	0.205
							112.94432

2.2.2

1

800~1250

N₂

Si + O₂ SiO₂

B₂H₆

N- PH₃ P⁺

2PH₃ 2P + 3H₂

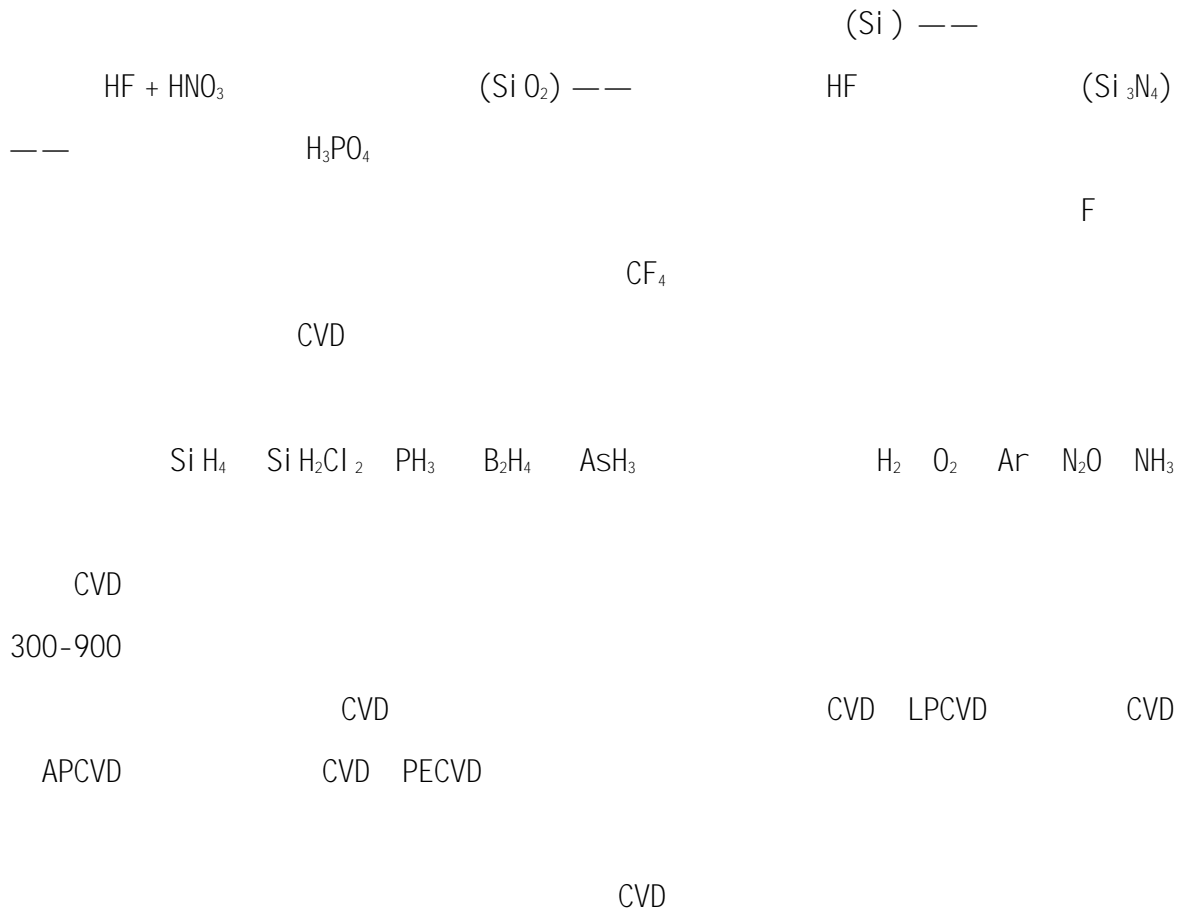

CMP CMP

2

2-2-1

HF

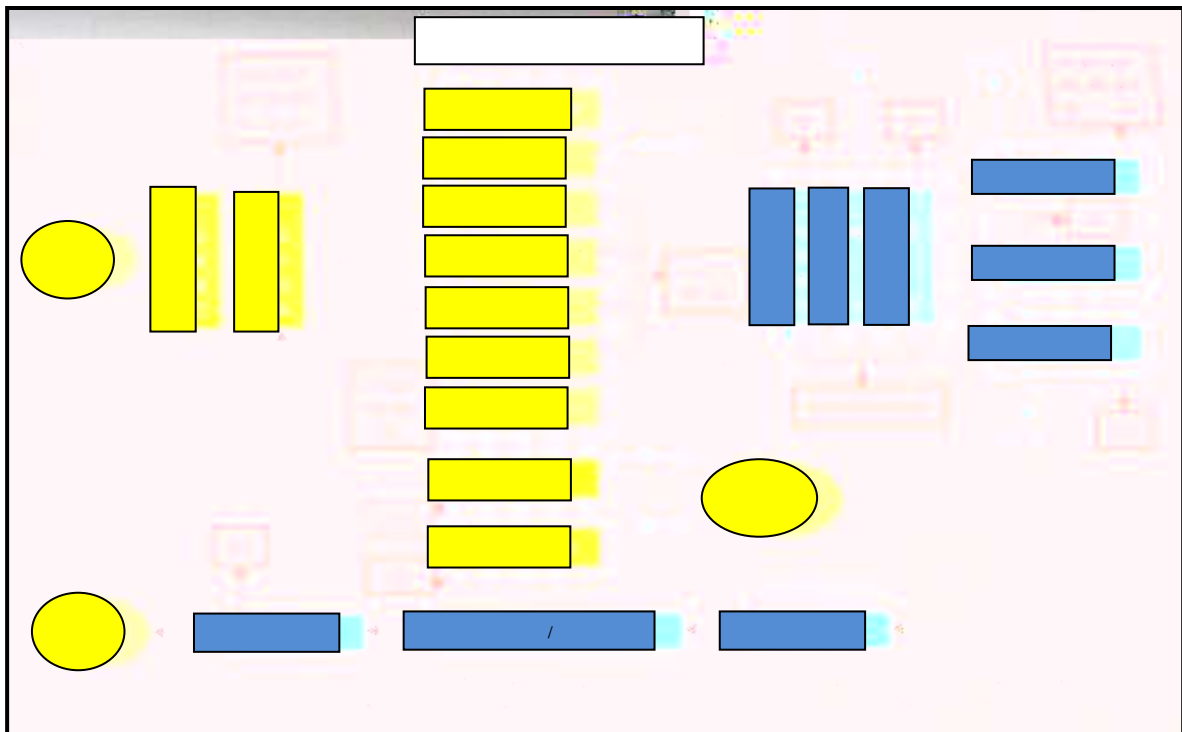

2-2-1

2.2.3

" "

1

1

2017

CUB

2

A-0

2017

2

1

HF H₂SO₄

HCl

(SiH₄)

(PH₃)

(AsH₃)

CMP

NH₃

VOC

2017

3

2107

100%

GFAB2-P18597-2001

2017

2.2.4

1

2016

2

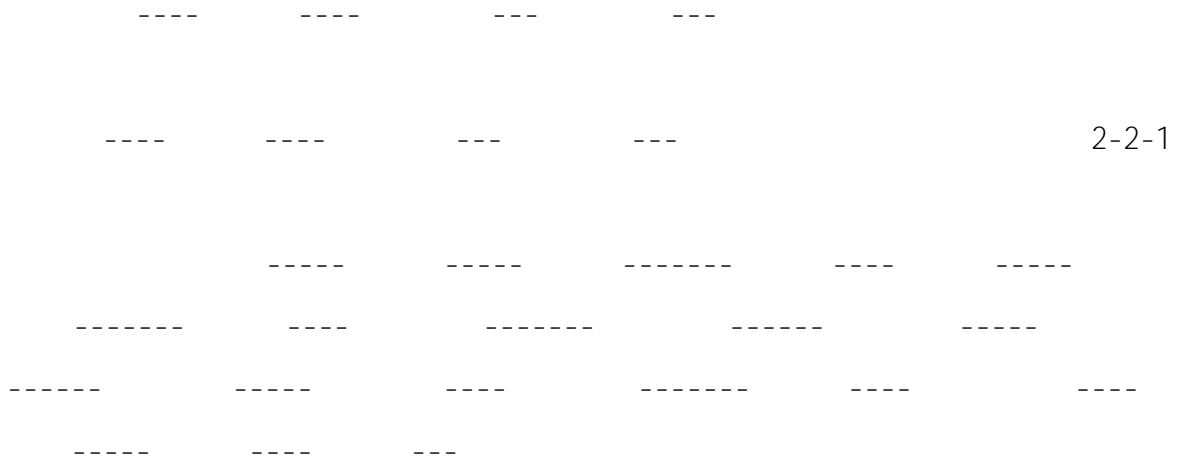

2.3

2.3.1

2-3-1

DqrØÀ

			m			
			480	5000		
			770	1200		
			920	3000		
			1110	5200		
			1130	580		
			1360	1500		

			470	5000		
			930	2500		
			1270	3000		
			1260	8000		
			1450	1500		
			1340	600		
			2260	800		
			2890	20000		
			100	GB3838-2002		V
	200m			GB3096-2008		3

2.3.2

2-3-1

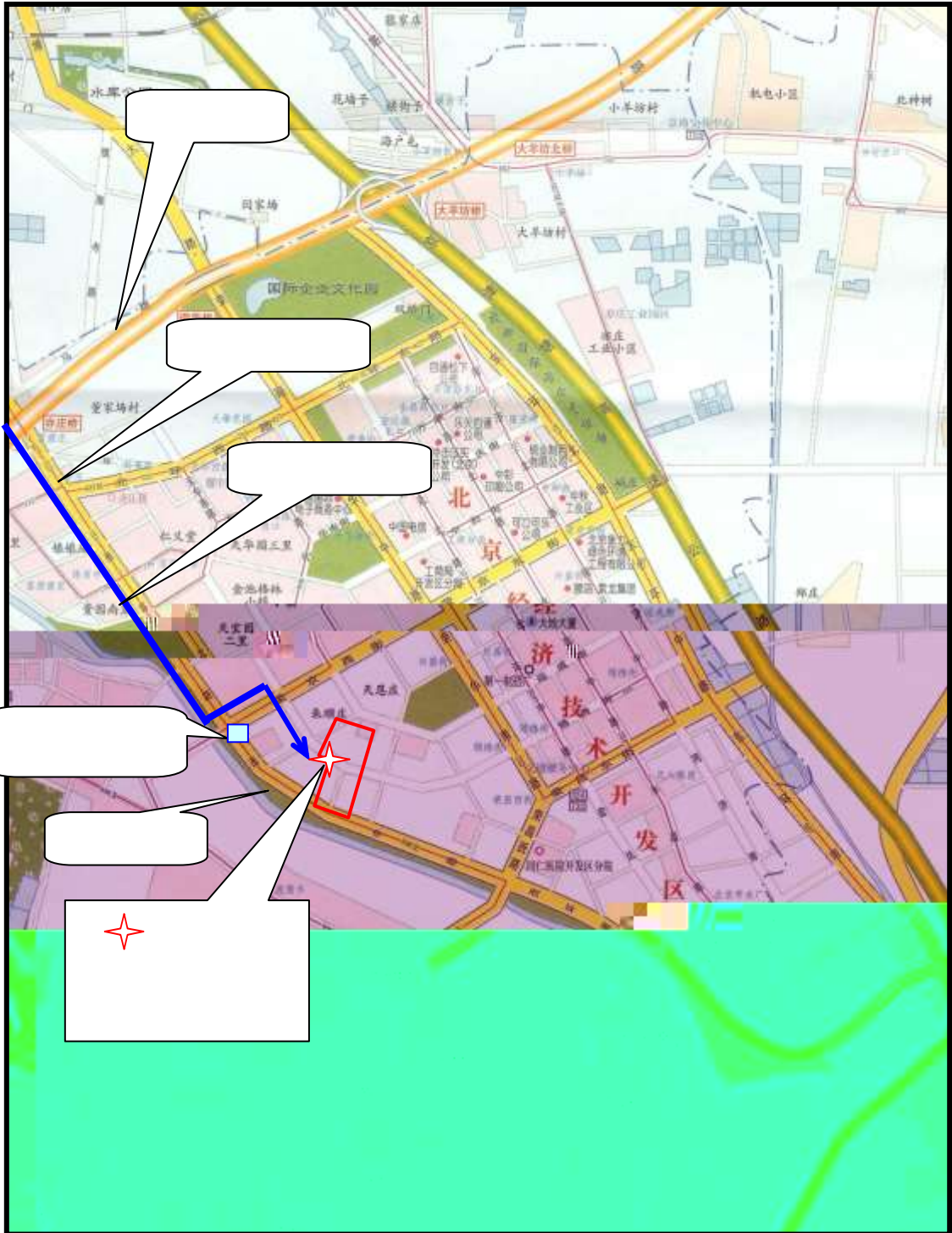

2-3-1

2.4

2018

2018

2-4-1 2015-2018

2-4-1

2-4-1 2018

1	1. 9	Gas Leak	H ₂
2	1. 12	Chemical Leak	
3	1. 17	Fire Alarm	(FAC)
4	1. 24	Gas Leak	EIHCV01 PH ₃

5

24	6. 20	Chemical Leak	FTECP05 H ₂ SO ₄
25	6. 26	Bad Weather	(FAC/EE)
26	6. 28	Fire Alarm	
27	7. 16	Gas Leak	EIMCV02 AsH ₃ Leak Hi Hi
28	7. 18	Water Leak	P1A Local Scrubber
29	7. 31	Fire Alarm	PC (FAC/Water)
30	7. 31	Elevator	FAB P1B
31	8. 6	Gas Leak	Cl F ₃ ERCV
32	8. 17	Fire Alarm	
33	8. 23	Chemical Leak	H ₃ PO ₄
34	8. 29	Fire Alarm	FPBAC01 FDSOR18
35	8. 31	Fire Alarm	VOC ()
36	9. 7	Confined Space	
37	9. 12	Chemical Leak	HF
38	9. 21	Gas Leak	ETPOX07 NH ₃
39	9. 25	Fire Alarm	PC ()
40	9. 28	Terrorist	
41	10. 8	Fire Alarm	EDSOR01
42	10. 17	Fire Alarm	PS2 1F
43	10. 25	Confined Space	
44	10. 31	Fire Alarm	EPAFS01
45	11. 7	Fire Alarm	EDISG02 EWNSF91
46	11	Evacuation	
47	11. 16	Chemical Leak	H ₂ SO ₄
48	11. 22	Fire Alarm	B2
49	11. 28	Fire Alarm	
50	12. 5	Fire Alarm	
51	12. 11	Gas Leak	GTLOK06 NF ₃
52	12. 14	Fire Alarm	IT ()
53	12. 20	Fire Alarm	FAB2-P1B 1F IPA
54	12. 26	Bad Weather	

2-4-2 2015-2018

2015	59		1.	2
			2.	1
			3.	1

3.1

3.1.1

3.1.1.1

1

2

50

GB6944-2012

3

3.1.1.2

3.1.2

HJ/T169-2004

(GB5044-85)

(GB13690-92)

3-1-1

3-1-2

3-1-1

		LD ₅₀ () mg/kg	LD ₅₀ ()mg/kg	LC ₅₀ (4)mg/L
	1	<5	<1	<0.01
	2	5<LD ₅₀ <25	10<LD ₅₀ <50	0.1<LC ₅₀ <0.5
	3	25<LD ₅₀ <200	50<LD ₅₀ <400	0.5<LC ₅₀ <2
	1	20 20		
	2	21 20		
	3	55		

1 2

3

3-1-2

	LC ₅₀ mg/m ³	<200	200-	2000-	>20000
	LD ₅₀ mg/kg	<100	100-	500-	>2500
	LD ₅₀ mg/kg mg/m	<25	25-	500-	>5000

2					0.5000	
3					0.0046	

4

34	0.52% /				0.0603	
35					0.0046	

2.1



HCl

1

2-3

3.1.4

3.1.5

COD

CMP

6

3

24

35.8m 2014

15

pH COD

F⁻

2014

Cu²⁺

As²⁺

6

7



3-1-1

3.1.6

3-1-4

3-1-4

3.1.7

HJ/T 169-2004

GB18218-2014

GB18218-2014

3-5

B1A-B1C 1

- -

500m

3-1-5

3-1-5

qi /Qi

(t)

1				0.0200	5	0.0040
2				0.5000	5	0.1000
3				0.0046	1	0.0046
4				0.0062	5	0.0012

7				0.3900	0	0
8	0.95% /1.25% /			0.0132	200	0.0001
9	0.5% /			0.0195	200	0.0001
10				0.3600	10	0.0360
11				1.7820	200	0.0089
12				0.9500	50	0.0190
13				0.0100	200	0.0001
14				0.1200	0	0
15	20% /			0.0039	200	0.0000
16				0.0514	200	0.0003
17	5% /			0.0140	200	0.0001
18				2.4160	200	0.0121
19				1.9200	50	0.0384
20				0.0020	50	0.0000
21	1.25% /			0.0326	200	0.0002
22	30% /			0.0035	200	0.0000
23				0.0400	200	0.0002
24				0.2400	50	0.0048
25				0.5000	200	0.0025
26				0.2960	50	0.0059
27				0.0360	10	0.0036
28				0.6000	50	0.0120
29				0.0019	200	0.0000
30	1.2% /			0.0178	200	0.0001
31	5% /			0.0022	200	0.0000
32	0.95% /3.5% /			0.0350	200	0.0002
33	3.5% / /			0.0519	200	0.0003
34	0.52% /			0.0603	200	0.0003
35				0.0046	50	0.0001
36	5%			0.0132	200	0.0001
37				0.0907	10	0.0091
38	1% /			0.0220	200	0.0001
39	50% /			0.0008	200	0.0000
40				26.6000	100	0.2660
41				2.6521	200	0.0133
42				7.8720	0	0
43				2.3520	1000	0.0024
44				12.3220	0	0

45				9.8120	0	0
46				21.3000	0	0
47				0.2370	500	0.0005
48				14.7500	100	0.1475
49				0.0200	0	0
50				0.0100	50	0.0002
51				26.6800	500	0.0534
52	-1.2-			0.0210	5000	0.0000
53				0.4540	10	0.0454

1

2

$$q_1/Q_1 + q_2/Q_2 + q_3/Q_3 + \dots + q_n/Q_n = 1$$

$$\frac{q_1}{Q_1} + \frac{q_2}{Q_2} + \frac{q_3}{Q_3} + \dots + \frac{q_n}{Q_n} = 1$$

3

500m

$$\sum \frac{q}{Q} = 0.8087 \quad 1$$

3.2

1

2

3

4

5

6

7

3.3

3.3.1

1

	1969	1987	1000
		16.8%	
	35.1%		18.2%
15.6%	12.4%		
1949~1982			13440
			17
			19
	261	1.94%	1056
			7.86%
			505
			3.76%
828	6.16%		6165
			45.87%
1076	8.00%	651	4.84%
			784
			5.83%
	138	1.03%	40
			0.29%
			57
0.42%			

2

3.3.2

0

3-3--1

3-3-1

/	a^{-1}	a^{-1}	
	1×10^6		
	1×10^6	1×10^{-8}	
	1×10^6	1×10^{-7}	
Miljøstyrelsen	1×10^6		
Travis	1×10^6		

3-3-2

10^{-6}

3-3-2

/		
10 ⁻³		
10 ⁻⁴		
10 ⁻⁵		
10 ⁻⁶		
10 ⁻⁷ 10 ⁻⁸		

3-3-3

3-3-3

		/
1		3.3 × 10 ⁻⁶
2		3.3 × 10 ⁻⁴
3		2.0 × 10 ⁻⁵

43%

32.1%

13.7%

11.2%

3.4

1
SSW 2.5m/s
0.5m/s 1.5m/s 2.5m/s
F

2
1
F 0.5m/s 1.5 m/s 2.5m/s

1mi n-30mi n

140.56 mg/m³

1.5m/s

F

1390mg/m³

IDLH

2

F

0.5m/s 1.5m/s 2.5 m/s

1

1mi n-40mi n

94.29 mg/m³

1.5m/s

F

850mg/m³

IDLH

461.4

461.4 IDLH

3-4-1

3-4-1 IDLH

			m
		S	
		SW	50
		S	280
		SW	340
		S	350
		NW	
BDA		N	260

3
 F 0.5m/s 1.5m/s 2.5 m/s
 1 1mi n-20mi n

7.11mg/m³

1.5m/s F 13.5mg/m³
 IDLH

4
 F 0.5m/s 1.5m/s 2.7 m/s
 1 1mi n-20mi n

5.55mg/m³

1.5m/s F 390mg/m³
 IDLH

3

$$C = \frac{R \times P \times C}{P \times C} \times \frac{1}{2}$$

$$8.33 \times 10^{-5} / a$$

4

IDLH 1.5m/s F IDLH 461.4
 461.4 IDLH
 500m

3.5

3.5.1

1

()

2

NF₃ BCl₃ HBr HCl CO SiH₄ SiHCl₃ PH₃ NH₃

H₂ Cl₂ WF₆

24

3

4

HF HCl H₂SO₄ H₃PO₄ HNO₃ H₂O₂ NH₄OH

(PVC

)

5

T801

T802

6

7

a)

b)

c)

d)

3.5.2

GB 15603-1995

(1)

(2)

(3)

(4)

(5)

(6)

(7)

2.4.2.1

3 m/s

2.4.2.2

25

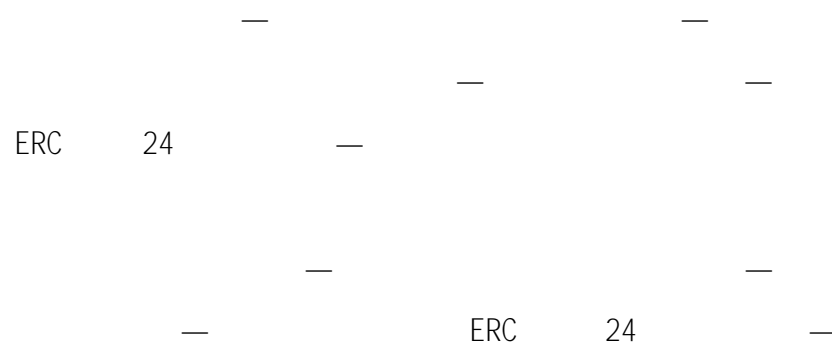

2.4.2.3

1

2

3

4

2.4.2.4

5km/h

GFAB2-P13392

3.6

3.7

3.7.1

3.7.2

3.7.3

1

F-

Cu²⁺

2

2

3

3

4.1

4.1.1

2018 2 5

Q

M

E

4.1.2

(Q)

500m

A

Q

112.9

Q

100

Q3

4.1.3

M

1

m1

300

p

10.0MPa

DIFF

38

54

M1

30

2

m2

m2

25

3

M = m1+m2=30+25=55

M3

4.1.4

E

5

5

500

1000

E1

4.1.5

Q

M

E

Q

Q3

M3

E

E1

5-1-5

4.1.6

Q 1

-

Q3-M3-E1

4.2

4.2.1

2018 2 5

Q

M

E

4.2.2

(Q)

1

Q

A

Q

112.6

Q 100

Q3

4.2.3

M

M

1

m1

300

p 10.0MPa

6

M1

30

2

m2

3

m2

6

M = m1+m2=30+6=36

M2

4.2.4

E

1 2 3
10

E1

4.2.5

0 03

M2

E

E1

5.1

5.1.1

1

2

ERC

ERC 8

1

2

7

5-1-1

2

5-1-1

ERC

11

1

2

ERT

5-1-2

3

ERC

ERC

21000 22000 21900

4

5

6

7

Bul k Gas ()



5-1-2

8

9

10

11

()

5.1.2

24

21000 22000 21900

29919

5-1-1

5-1-1

TF			DIFF			Q&R		
Metal	EE1	29387	FUR	EE1	29150	RE LAB	29470\20731	
	EE2	29386		EE2	29142			
CVD	EE1	29127	RTP	EE	29526	FA LAB	20721	
	EE2	29128	IMP	EE1	29145			
CMP	EE1	29373\29441		-				
	EE2	29609		EE2	29321			
FAC			MFG			ETCH		
ME	29051		MPC	29200		ETCH	29228\29536\29230	
EE	29053		OQI	29787				
WATER	29055		GTF	29578				
G&C	29057\29058		TF	29603				
FMCS	22222		DIFF	29195\29774		WET	EE1	29572
-	-		ETCH	29194\29218				
-	-		LITHO	29208\29207			EE2	29573
YE			LITHO			ME		
EE	29104		EE1	29158		29663\29545		
PIE			EE2	29156				
EE	29272		-	-				
OS			Wafer Reclaim			Warehouse		
29382			20750			29296		
司机班			保洁			洗衣房		
20521			29244			20725		

5.1.3

5-1-2

5-1-2

部门	电话	备注
火警	119	
急救	120/999	
交通事故	122	
警匪	110	
亦庄开发区安监局	6788 0165 (白天)	重大安全损失及人员伤亡 地震、安全评估
	6788 1105 (夜间)	
亦庄开发区应急办	6788 1207	应急救援抢险
北京市质监局开发区分局	6788 7103	
亦庄消防中队	6788 7947	
亦庄消防支队	6787 6119	
亦庄派出所	6788 1733	偷盗事件、破坏公司财产、打架斗殴
亦庄天华路派出所	6787 1502 或 1512	偷盗事件、破坏公司财产、打架斗殴
亦庄博兴路派出所	6785 3098	偷盗事件、破坏公司财产、打架斗殴
亦庄交通队	6788 1119	发生交通事故

单位名称	电话	备注
亦庄开发区管委会	6788 1207 1105 1118	开发区管委会主任(厂外)
亦庄医院急救	5826 6959	人员严重受伤
亦庄医院急诊	5826 6080	中毒
北京新大药厂中控室	6312 7204	SMIC 园区公司
北京法美高新中控室	6785 5033	SMIC 园区公司
北京大井芯光中控室	6785 5958	SMIC 园区公司(四环路)
北京普莱克斯中控室	6785 5660/5219 5662	SMIC 园区公司
北京北方微电子中控室	5784 6989 转 6700	文慧大道 8 号
和利时	5898 1000 转机	恒盛中路 2 号
国光高科中控室	6782 6666	西环中路恒盛南街
爱普益中控室	5977 3704	恒盛东路 1 号爱普益
盛普服装	8796 6078	
中国数码	5802 2288	恒盛北街 1 号 8 楼
康司达楼表	6781 6199	恒盛南街
格美珂服饰	8537 2589	恒盛中路 5 号

部门	电话	备注
北京永大电梯维修	6773 1778	
北京欧宾电梯维修	6356 2432	
北京市燃气保修	96777	
北京市热力集团	96069	
北京市供电局	6321 7119 或 95598	
北京市地震局	6261 4147	
北京城管热线	96310	

5.2

ERC

ERT

5-2-1

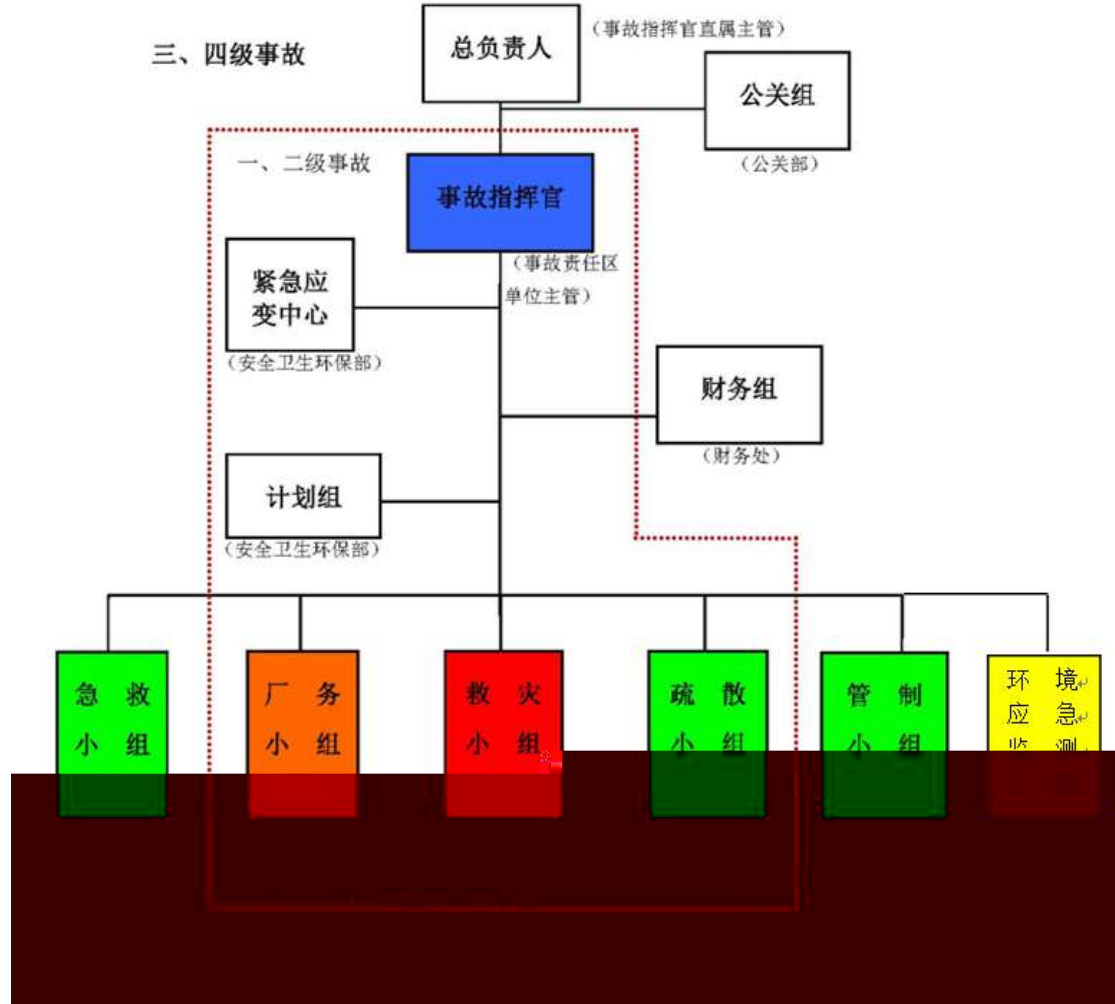

5-2-1

5.3

5.3.1

1	ERC		ERC	
2	ERC	layout	layout	
3			ESH	
4				
5		" "	" x "	" N/A"
	Fire alarm			
1	CCTV		local CO2	
	4	1	O2	
2	FAB	ERT	SCBA+ ERT Clean Room 2F&3F	
3				
4				
5				
6				
7	ERC			
8			Q&R	
9			FAC/ME	
10				
11				

1	ERC	ERC				
2	ERC	layout	layout			
3		ESH				
4						
5		" "	" x "	" N/A"		
	Gas alarm					
1	MSDS portable detector Detector detector	C4F6 C5F8 NF3 ESH	PPE Sampling tube PPE			
2	ERC	Detector	Trend,			
3	ERT	ERT				
4		Exhaust				
5						
6	Detector		Detector			
7	Portable Detector	Sampling Tube				
8	pump down					
9		ERC	GMS ERC			
10						

1	ERC	ERC	
2	ERC	layout	layout
3		ESH	

4		
5	" "	"x" " N/A"
	Chemical Leak	
1	MSDS	PPE
2	ERT	
3	ERT	Exhaust
4		ERT
5		
6		
7		
8		

1	ERC	ERC
2	ERC	layout layout
3		ESH
4		
5	" "	"x" " N/A"
	Water Leak	
1		PPE
2	ERT	
3	ERT	

4		
5		
6		
7		
8		
9		

1	ERC	ERC	
2	ERC	l ayout	l ayout
3	ESH		
4			

5

" "

0bn9UB0c1D%TbnP0&bnPPewrws(SDW&xE+VDrDk@)SDW&xE+00bBAVbDrGDbBAVbDbA&nD&saVOWd7va0D7&0bA

			2	ERC Leader ESH ESH	ERC	
			3			
	ERC		4			
	FAB Gowning Room		5			
2	ERC					
3	CCTV Fire door	FAB	6			
4						
5			7	CT2/	Level A ERT	
6	ERC		8	SCBA	ERT	
7			9	ERT		
8			10			
9			11			
10			12	ESH	ERC	
11			13			
12			14			
13			15			

14			16	ESH	CIP	
----	--	--	----	-----	-----	--

ERC						
CCTV						
1	Tool Detector Hi Hi Hi Alarm ENV Detector Alarm+Tool Detector Alarm GMS ERC FAB Gowning Room		1			
			2	ERC Leader	ESH	
			3			
			4	GMS		
2	ERC		5			
3	CCTV					
4	MSDS		6	Level A	Level C	
5			7	ESH FAC/G&C	SPM	
6	CCTV		8	PPE		
7			9	Layout		
8			10	ERT		
9			11			
10	PPE		12	Cabinet	ER	

ERC			
CCTV			

9	PPE		10		
10			11	ESH	ERC
11			12		
12			13		PPE
13			14	ESH	CIP
14					

ERC					
CCTV					
1			1		
			2	ERC Leader, ESH	
			3		
2	ERC		4	CCTV	
3	PH		5		
	ERC				
4	PH				
5			6	PPE	

6			7	ERT	
7			8		
8	cabiniet	ER	9	PPE	
9			10	PPE	
10			11	ESH	CIP

	ORE Lab	Fab2-P1C 1F			
6			6	Warehouse 29296	3#
7			7	ERT ...	ERT
8			8		Layout
9			9		
			10	lost MPC	Move 29200

ERC					
CCTV					
1	1		1		
	4		2	ERC Leader	ESH
	ERC		3		
			4	ERC VESDA	
			5		VESDA
2	ERC		6	ERT ...	ERT
3	CCTV		7		

			Layout	
5			9	
6			10	
7			11	ERC

5.3.3

1	ERC			
2	Fire door	FAB		
3	ERT		SCBA	
4	ESH	ERC		
5				
6	ESH		CIP	
7	ESH	ERC		
8	GP-01			
9	SCBA			
10				
11	ERT		(ERT
			SCBA)
12				
13				
14				
15				
16				

17		
18		

1		
2	PPE	
3		
4		
5	ESH ERC	
6	ESH CIP	
7		
8	SCBA	
9	ERT	
10	ERC	
11	ERT (SCBA) ERT	
12		
13		
14		
15		
16		
17		
18		

1		
2	ERC VESDA	
3	VESDA	

4	Down	
5	ERT (SCBA) ERT	
6		
7		
8		
9		
10		
11		
12		

1	ERC VESDA	
2	VESDA	
3		
4		
5		
6	ERT (SCBA) ERT	
7		
8		
9		
10		
11		
12		
13		

5.3.4

1	ERC ERC
2	layout
3	" " "x "
	Fire alarm

5		
6	GMS	Root cause.

1	ERC	ERC
2	layout	
	Power Off&	
1	ERT	PPE
2	ERT	
3		

1	ERC	ERC
2	layout	
	Water leak	
1	PPE	
2	ERT	
3	ERT	
4		
5		

1	ERT	ERC	ERC
Fire alarm			
1	:	PPE , FAB ERT	ERC

3		
---	--	--

4

4	ERT	20	
5			
6	ERC		
7	ERT	/	PPE /
8	Fab2-P1C	Gowning Room	Fab2-P1C 5

1			
1	FAB		
2	ERC	1\3#	
3			ERC

1	ERT	ERC	ERC
2		" "	" x "
	Fire alarm		
1			ERC
2			
3			
4			
5			
6			
7			

8		
9		

1	ERT	ERC	ERC
2		" "	" x "
	Gas alarm		
1	EXHAUST SCRUBBER		
2	BULK GAS		
3			
4			
5			
6			
7	FAC	Gas leak,	ERT
8			

1	ERT	ERC	ERC
2		" "	" x "
	Chemical leak		
1	ERC		
2	chemi cal		
3			
4	Exhaust	Scrubber	
5			

6		
7		
8		

5.3.5

	&			
ESH	ERO		SMIC	
FAC	QE			
	&	---	---	
		---	---	
		---	---	
		---	---	
Module				
OE	ESH		FAC	
GA			---	
HS			---	
Finance		---	---	

6.1

1

2

3

HF HCl H₂SO₄ H₃PO₄ HNO₃ H₂O₂ NH₄OH

(PVC

)

4

T801

T802

4

2

110+350m³

1~2

2

800+1800 m³

1871m³

(935.66m²*2m)

5

T802

T801

UPS

UPS

- a)
- b)
- c)
- d)

6.2

Early Smoke Detector Apparatus) (VESDA, Very Early Smoke Detector Apparatus)
(Fire Alarm System)
(GMS, Gas Monitor System)

1

ERC

H₂ Cl₂ WF₆ NF₃ BCl₃ HBr HCl CO SiH₄ SiHCl₃ PH₃ NH₃

ERC

LAYOUT

ERC

2 CCTV

ERC

3

4

pH

COD

5

6

PS2

FAB2-P1

7

8

6.3

(ERC, Emergency Response Center)

24

24

()

()

7.1

7.1.1

1

10

1

2

30

3

10

4

30

1

2

3

7-1-1

7-1-1

1	
2	(<5)
3	, 10 ()

4	() ,
1	
2	, 1
3	, 1 ()
4	() ,
1	() (<20)
2	2
3	()
4	() () ,
1	3 1
2	10 2
3	10
4	6 ,

7.1.2

1

2

7.1.3

火灾处理流程

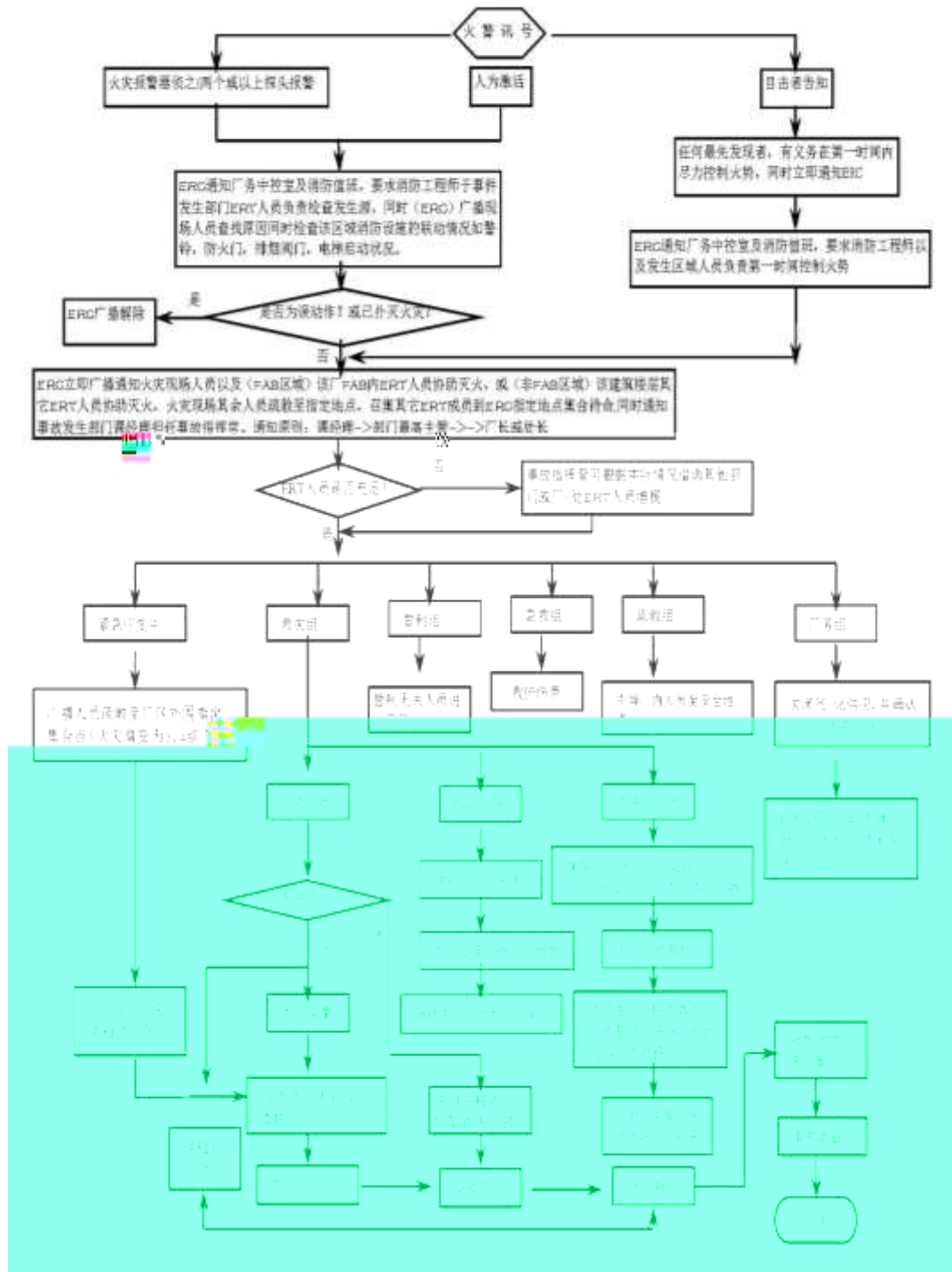

7.1.4

气体警报处理流程

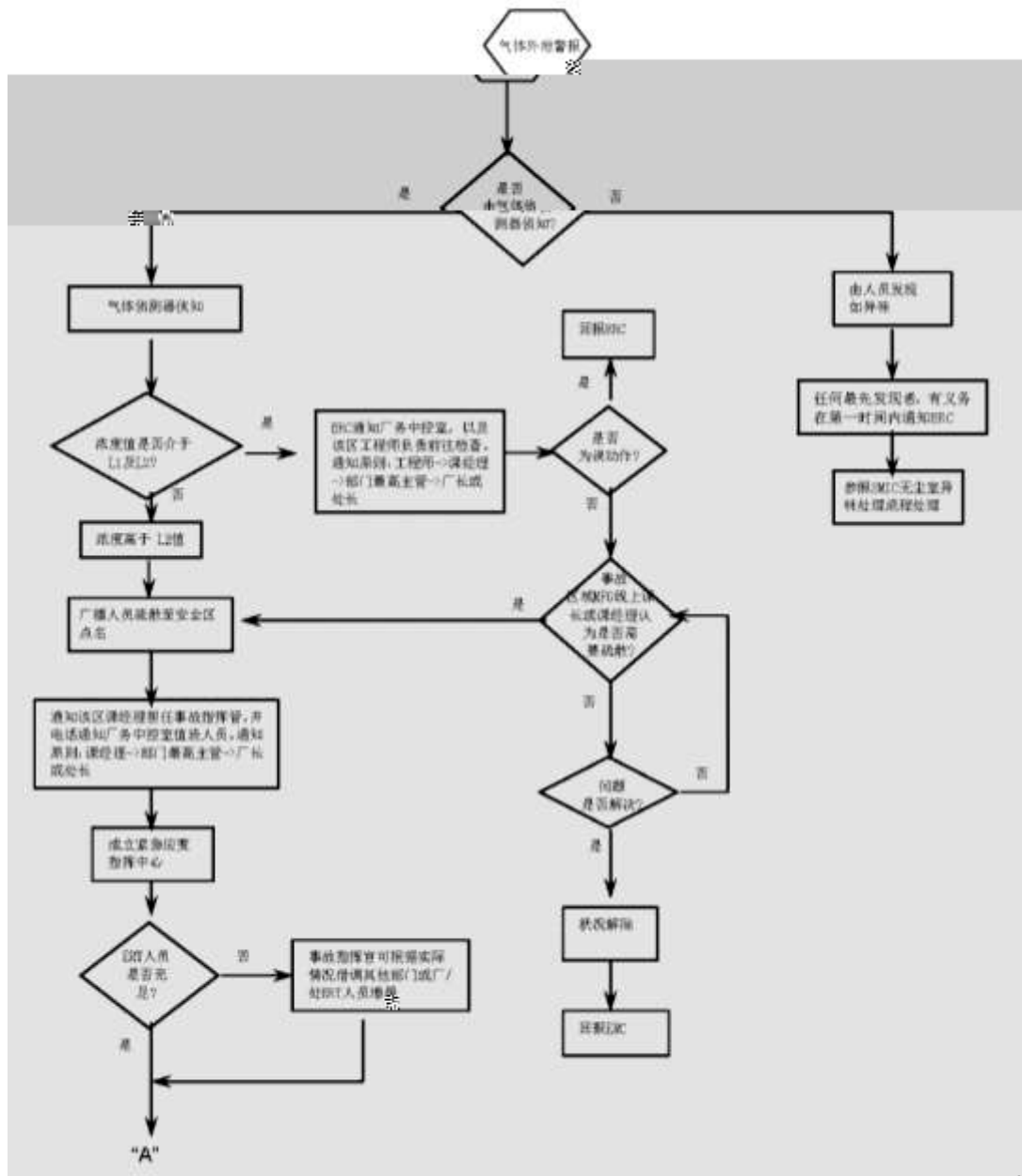

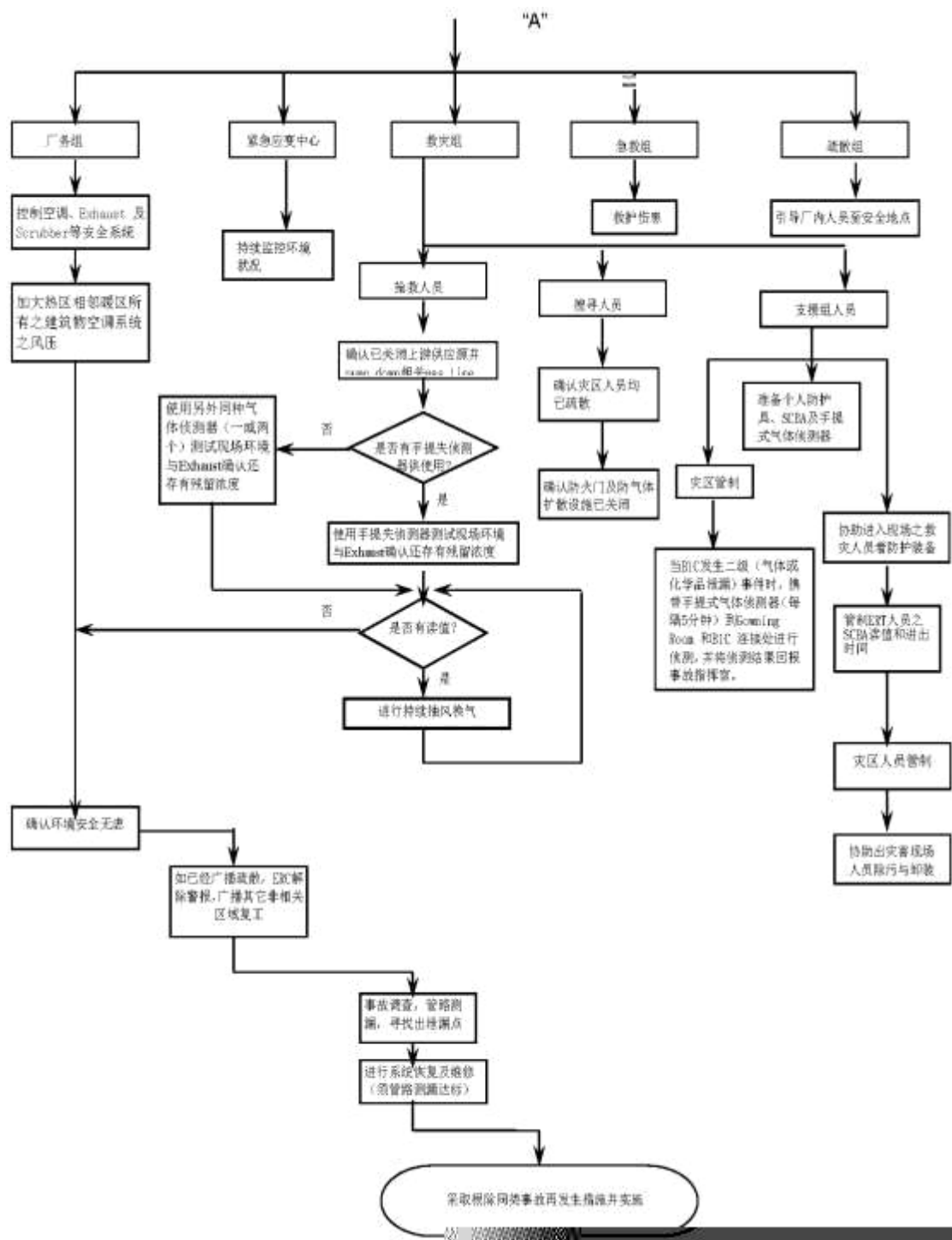

7.1.5

气体泄漏现场处理步骤

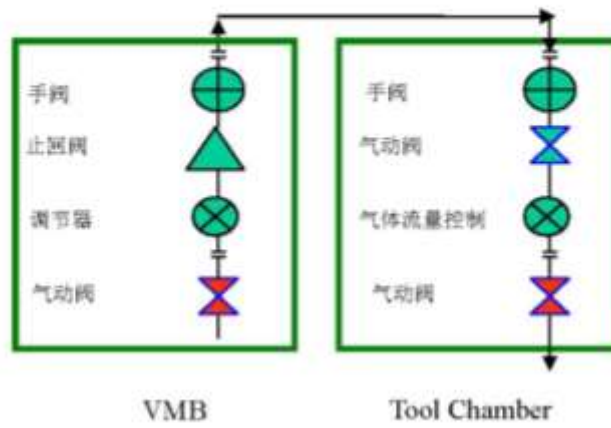
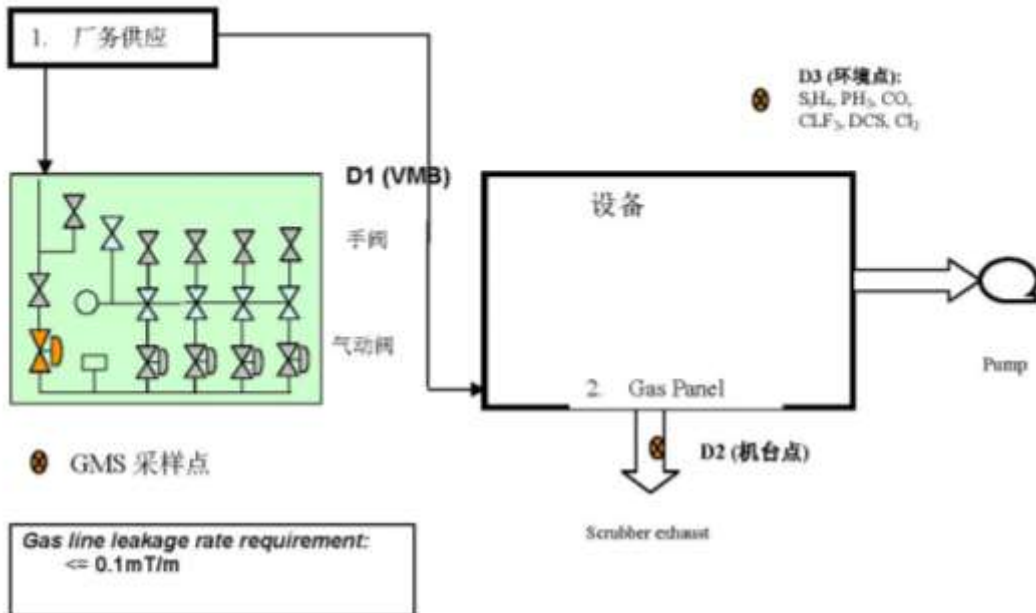

7.1.6

化学品外泄处理流程

注：
对其它设备课standby于ERC外安全走廊
之支持人员，指挥官须衡量应变需要，
若不需要，应令其解除支持任务。

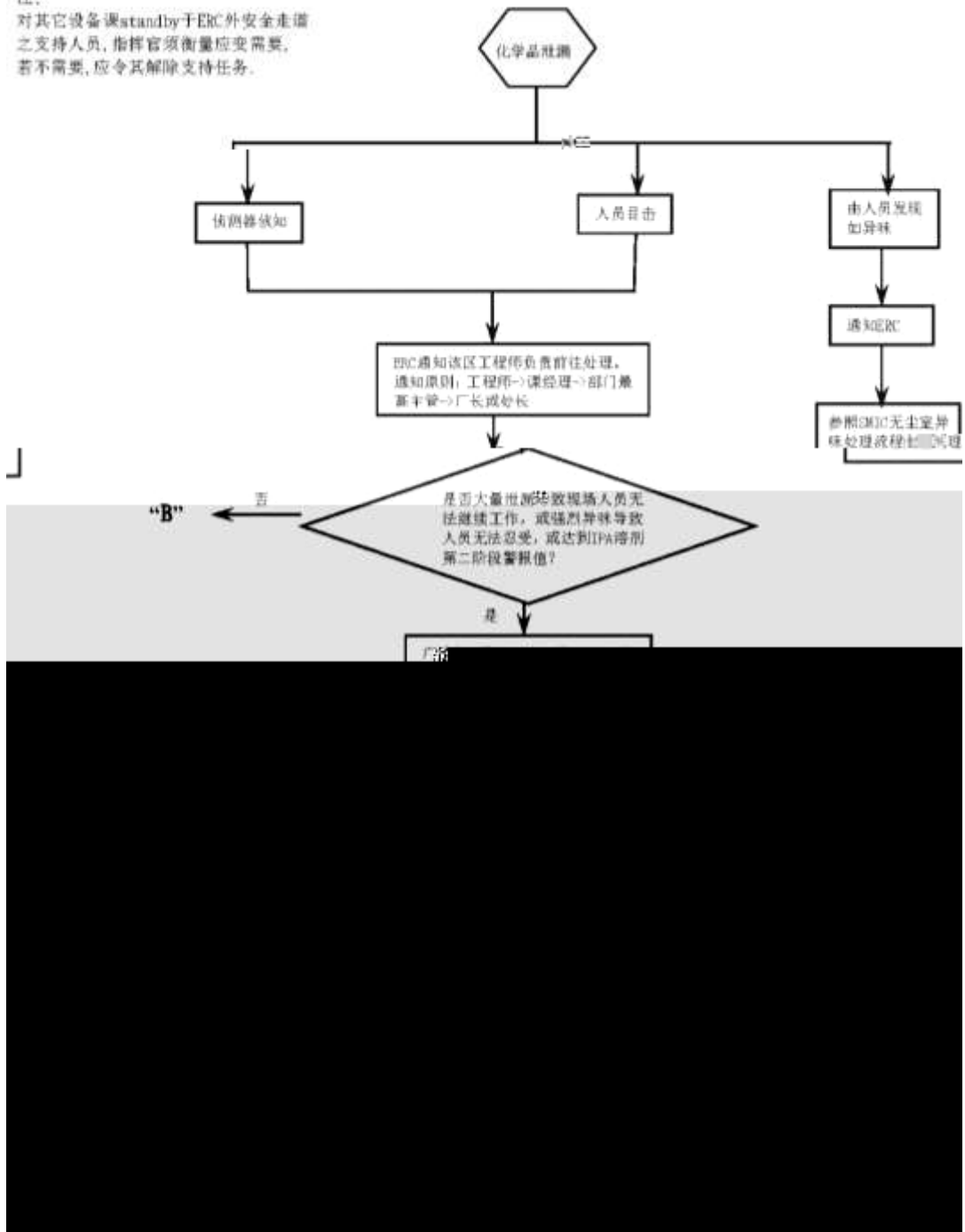

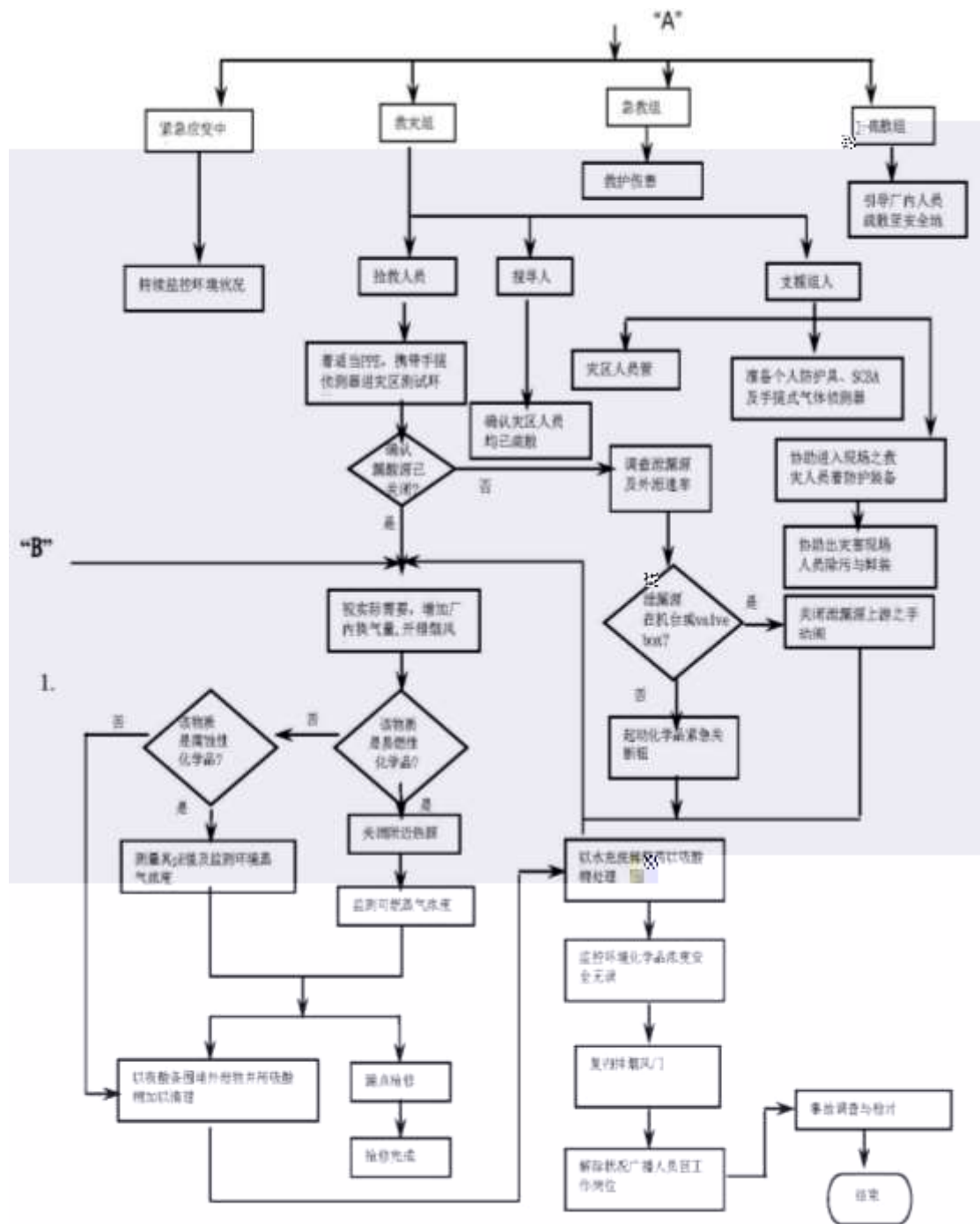

“B”

1.

不明漏液处理流程

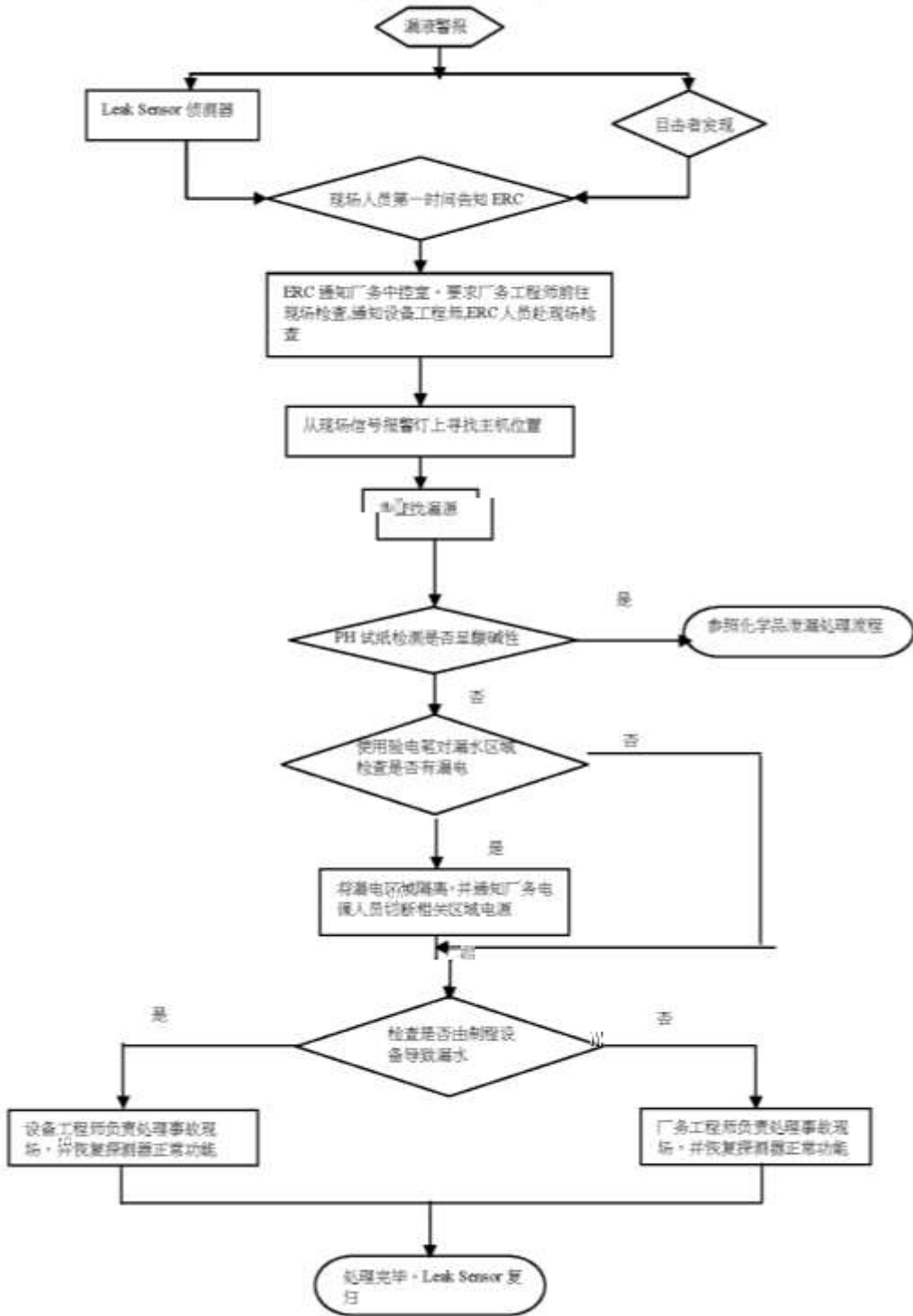

7.1.7

电力中断处理流程

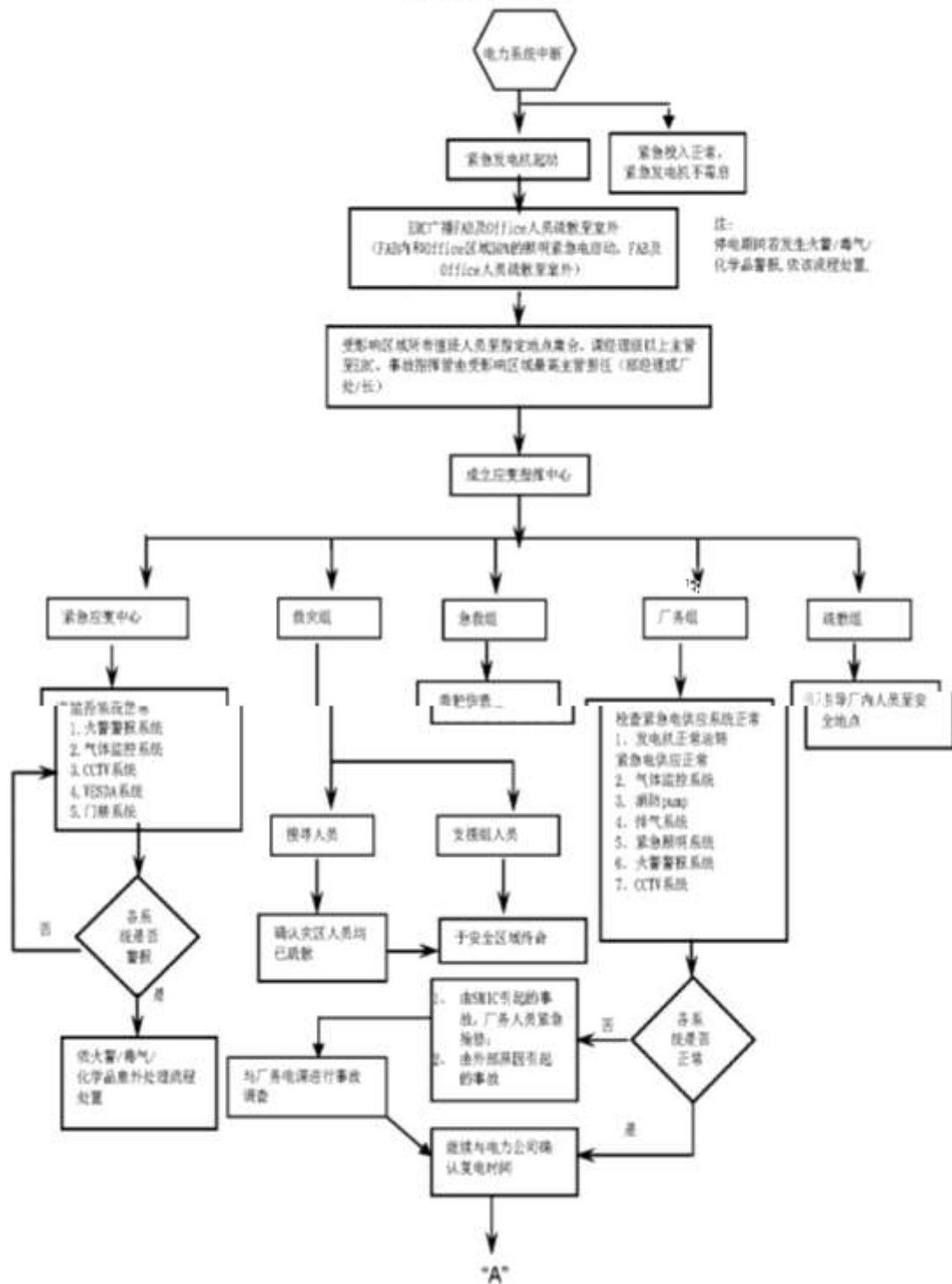

“A”

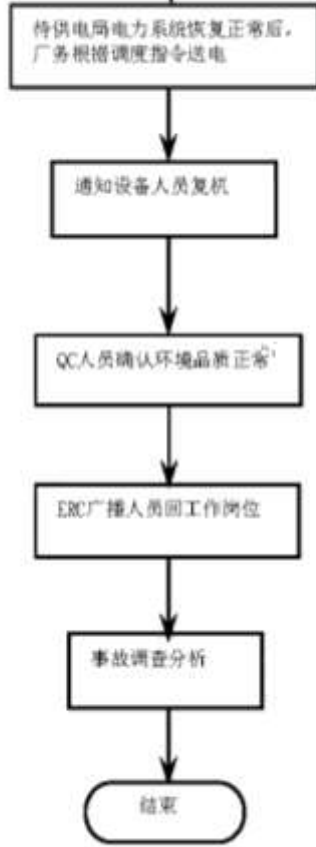

7.1.8

地震处理流程

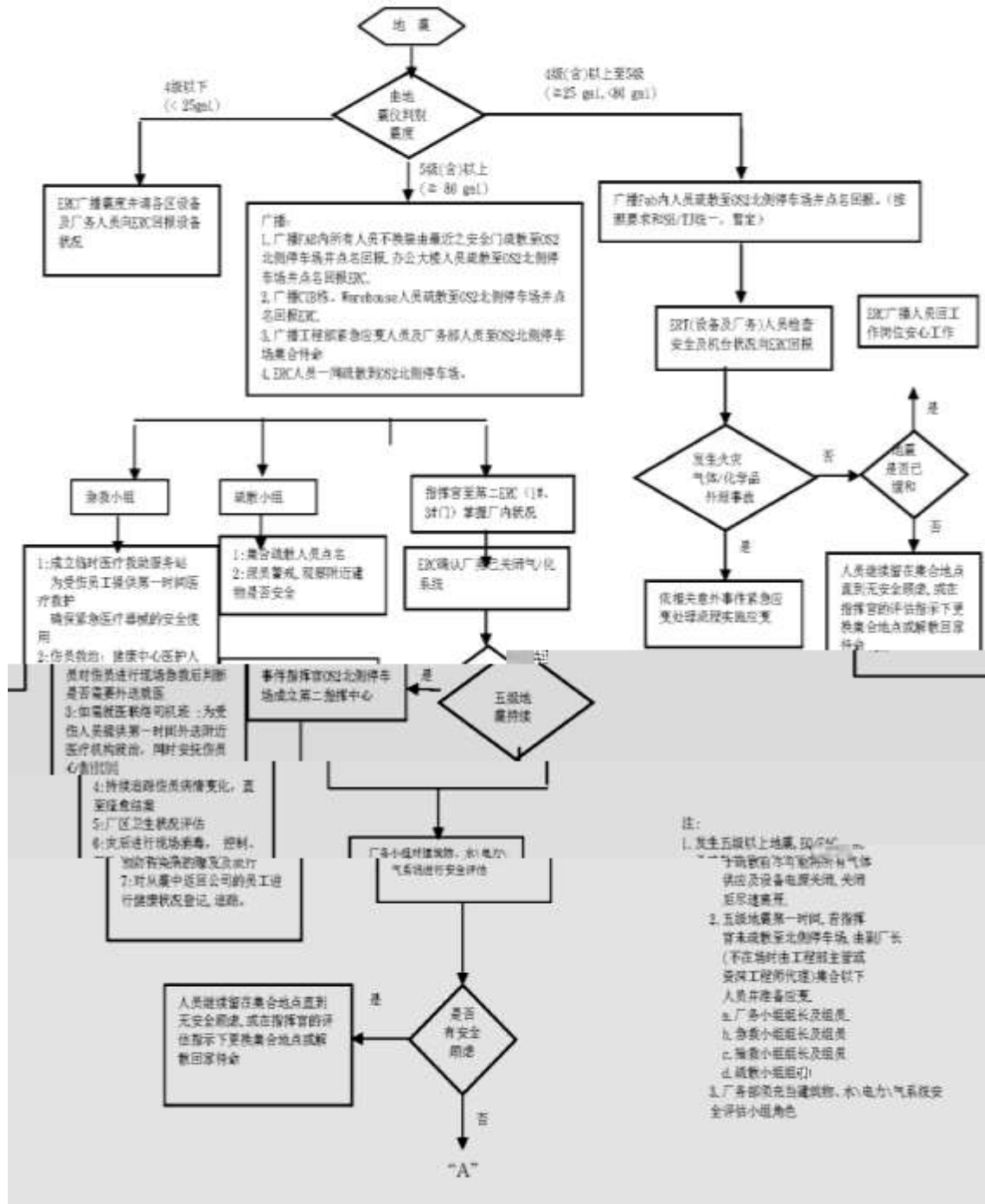

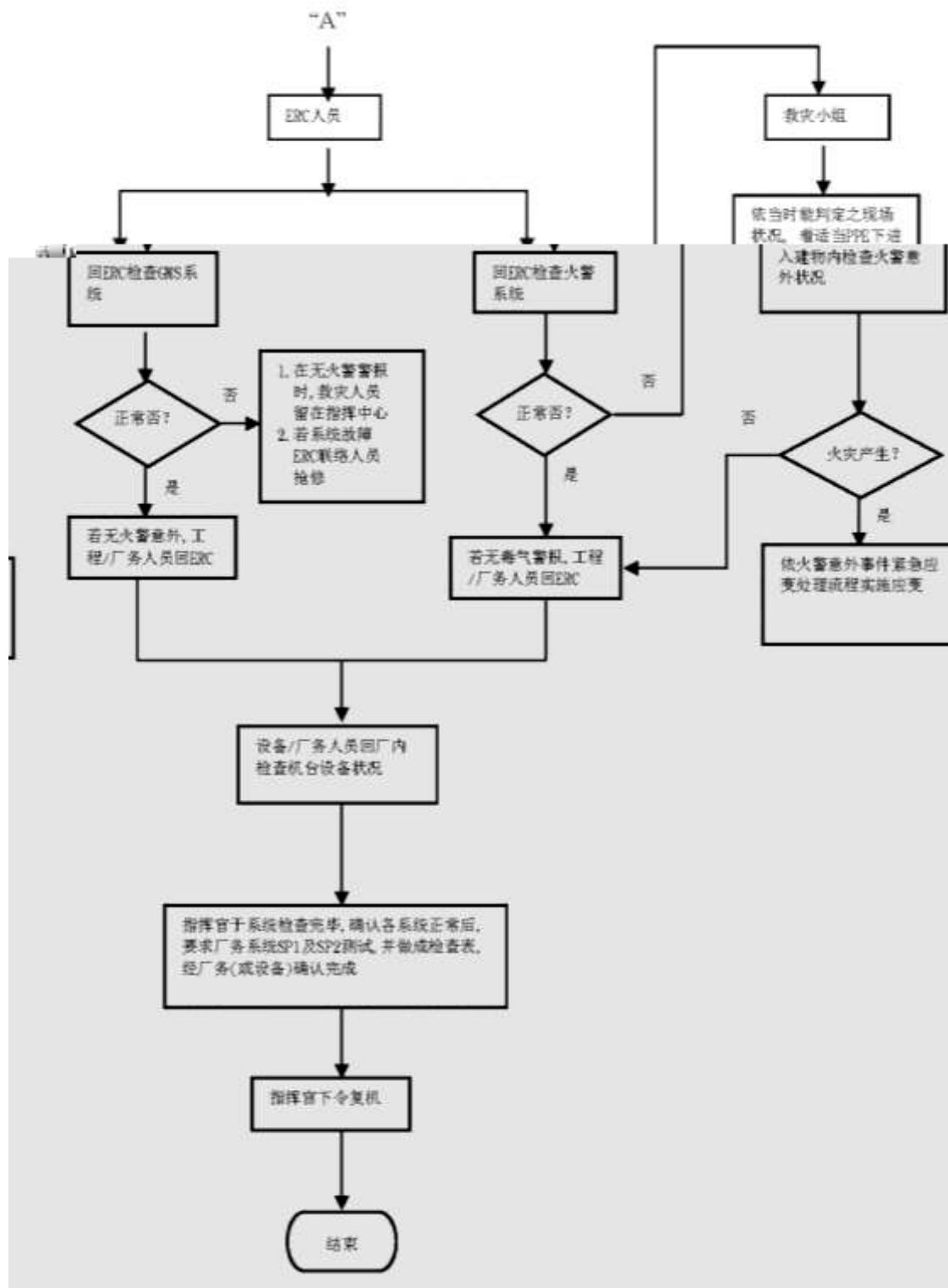

7.1.9

外部紧急事故处理流程

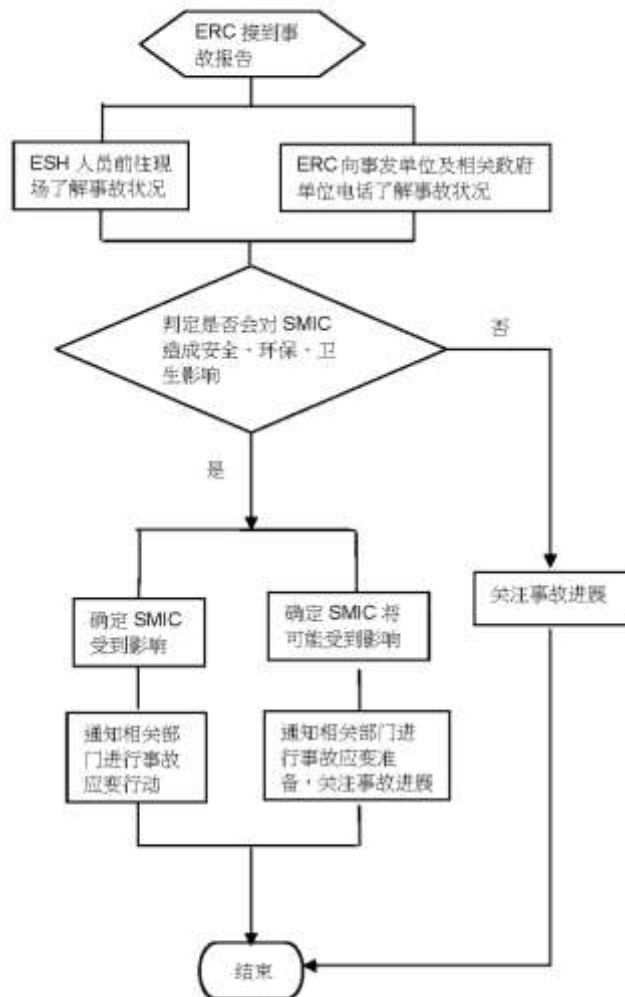

7.1.10

暴雨事件处理流程



7.3

7.3.1

LAYOUT

2

3

/

4

6-2

5

7.3.2

7.3.2.1

1





a. b.

c.

a. b.

c.

a.

b.

2

7.3.2.2

7.3.2.3

2

100m

"

"

50m

100m

50m

"

"

3

4

5

7.3.7

50

3

7.3.8

1

3

7.4

IDLH

1.5m/s

F

IDLH

461.4m

461.4

IDLH

500m

7.4.1

1

ERC

2

ERC

[

]

FAB2-P1-A, FAB2-P1-B

FAB2-P1-A, FAB2-P1-B ERT

FAB2-P1-A, FAB2-P1-B

FAB2-P1-C 3F Gowni ng Room

ERT

ERC

ERT

FAB2-P1-C

FAB2-P1-C

FAB2-P1-C ERT

FAB2-P1-C 3F Gowni ng Room

ERT

ERC

ERT

FAB2-P1-A, FAB2-P1-B

B01

ERT

B01

ERT

ERC

ERT

CW2 PS2 CUB2

ERT

ERT

FAB2-P1-A 1F FAB2-P1-B 1F , SIH4

ERT

ERT

FAB2-P1-C 1F

ERT

ERT

SMIC(BJ)

FAB2-P1-C non-copper(3F) and FAB2-P1-C
copper(2/3F)

3

FAB2-P1-A, FAB2-P1-C

B01

CW2 PS2 CUB2 SIH4

B01 FAB2-P1-C

B01

SMIC(BJ)

4

FAB2-P1-A (2/3F), FAB2-P1-B (2/3F), FAB2-P1-C non-copper(3F) and
FAB2-P1-C copper(2/3F), FAB2-P1-C 2F WAT

B01

ERT

ERC ERT

FAB2-P1-A 1F/ FAB2-P1-B 1F

B01

ERT

SIH4

ERT

CW2

CW2

ERT

FAB2-P1-C 1F

B01 ERT

B01, FAB2-P1-A, FAB2-P1-B, FAB2-P1-C, CUB2, PS2, CW2, Si H4

7.4.2

1

[

]

ERC

ERC

2

,1

Gas Detector

[]

FAB2-P1-A (2/3F), FAB2-P1-C (2/3F), FAB2-P1-C 2F WAT

FAB2-P1-C 3F Gowning

ERT

ERC

ERT

SMIC(BJ)

FAB2-P1-A 1F/FAB2-P1-B 1F

FAB2-P1-A

1F/FAB2-P1-B 1F

ERT

CW2

CW

ERT

SiH₄

SiH₄

ERT

FAB2-P1-C1F

FAB2-P1-C 1F

ERT

3

FAB2-P1-A, FAB2-P1-B , FAB2-P1-C, B01

B01

CUB2 CW2 SIH₄ PS2

SMIC(BJ)

4

FAB2-P1-A (2/3F), FAB2-P1-B (2/3F), FAB2-P1-C non-copper(3F) and
FAB2-P1-C copper(2/3F), FAB2-P1-C 2F WAT

B01

ERT

ERC ERT

FAB2-P1-A 1F/ FAB2-P1-B 1F

ERT

CW2

CW2

ERT

SIH₄

ERT

FAB2-P1-C 1F

FAB2-P1-C 1F

ERT

7.4.3

1

[

]

IPA

ERC

ERC

2

FAB2-P1-A (2/3F), FAB2-P1-B (2/3F), FAB2-P1-C non-copper(3F) and
 FAB2-P1-C copper(2/3F), FAB2-P1-C 2F WAT ,
 FAB2-P1-C 3F Gowning ERT ERC ERT

SMIC(BJ)

CW

CW

ERT

FAB2-P1-A 1F/ FAB2-P1-B 1F FAB2-P1-A 1F/
 FAB2-P1-B 1F ERT
 FAB2-P1-C 1F FAB2-P1-C 1F
 ERT

3

FAB2-P1-A, FAB2-P1-B 1F FAB2-P1-C, B01
 B01
 CW2 CUB2 SIH4 PS2
 SMIC(BJ)

4

FAB2-P1-A (2/3F), FAB2-P1-B (2/3F) , FAB2-P1-C non-copper(3F) and
 FAB2-P1-C copper(2/3F), FAB2-P1-C 2F WAT

		B01	ERT
ERC	ERT		
FAB2-P1-A 1F/	FAB2-P1-B 1F		
		ERT	
CW2		CW2	ERT
FAB2-P1-C 1F		FAB2-P1-C 1F	
	ERT		

7.4.4

1

2

FAB2-P1-A (2/3F), FAB2-P1-B (2/3F), FAB2-P1-C non-copper(3F) and FAB2-P1-C copper(2/3F), FAB2-P1-C 2F WAT

FAB2-P1-C 3F Gowni ng Room	ERT	ERC
ERT		

SMIC(BJ)

3

FAB2-P1-A (2/3F), FAB2-P1-B (2/3F), FAB2-P1-C bui l di ng non-copper(3F) and FAB2-P1-C copper(2/3F), FAB2-P1-C 2F WAT

FAB2-P1-C 3F Gowni ng Room	ERT	ERC
ERT		

SMIC(BJ)

4 ()

FAB2-P1-A FAB2-P1-B FAB2-P1-C B01

CUB2 PS2 CW2 SI H4 B01 B01

SMIC(BJ)

SMIC(BJ)

SMIC(BJ)

ERT

FAB2-P1-A (2/3F), FAB2-P1-B (2/3F), FAB2-P1-C non-copper(3F) and
FAB2-P1-C copper(2/3F), FAB2-P1-C 2F WAT

FAB2-P1-C 3F Gowni ng ERT

ERC ERT

FAB2-P1-A (2/3F), FAB2-P1-B (2/3F), FAB2-P1-C non-copper(3F) and
FAB2-P1-C copper(2/3F), FAB2-P1-C 2F WAT

B01

ERT ERC ERT (

)

ERT

(B01)

ERC

ERC

7.5

7.6

5

01

SMIC(BJ)

(SMIC (BJ) Chemical Poisoning Rescue 0.1.)

SMIC (BJ)

0.1. SMIC (BJ) First-Aid Kit Management 0.1

SMIC (BJ)

SMIC (BJ) First-Aid Training Rule

SMIC(BJ)

0.1. SMIC (BJ) Emergency First Aid 0.1

120

24

7-6-1

7-6-1

1			120
2			999/120/58266699
3		/	999/120/67870497
4		/	999/120/69243653
5		/	999/120/85231000

SMIC BJ

7.7

1

2

3

8.1

—

ERC —

8-1-1

ERC ERC

48

ERC

ERC

1

2

3

48

ERC

ERC

()

2

1 ;

4

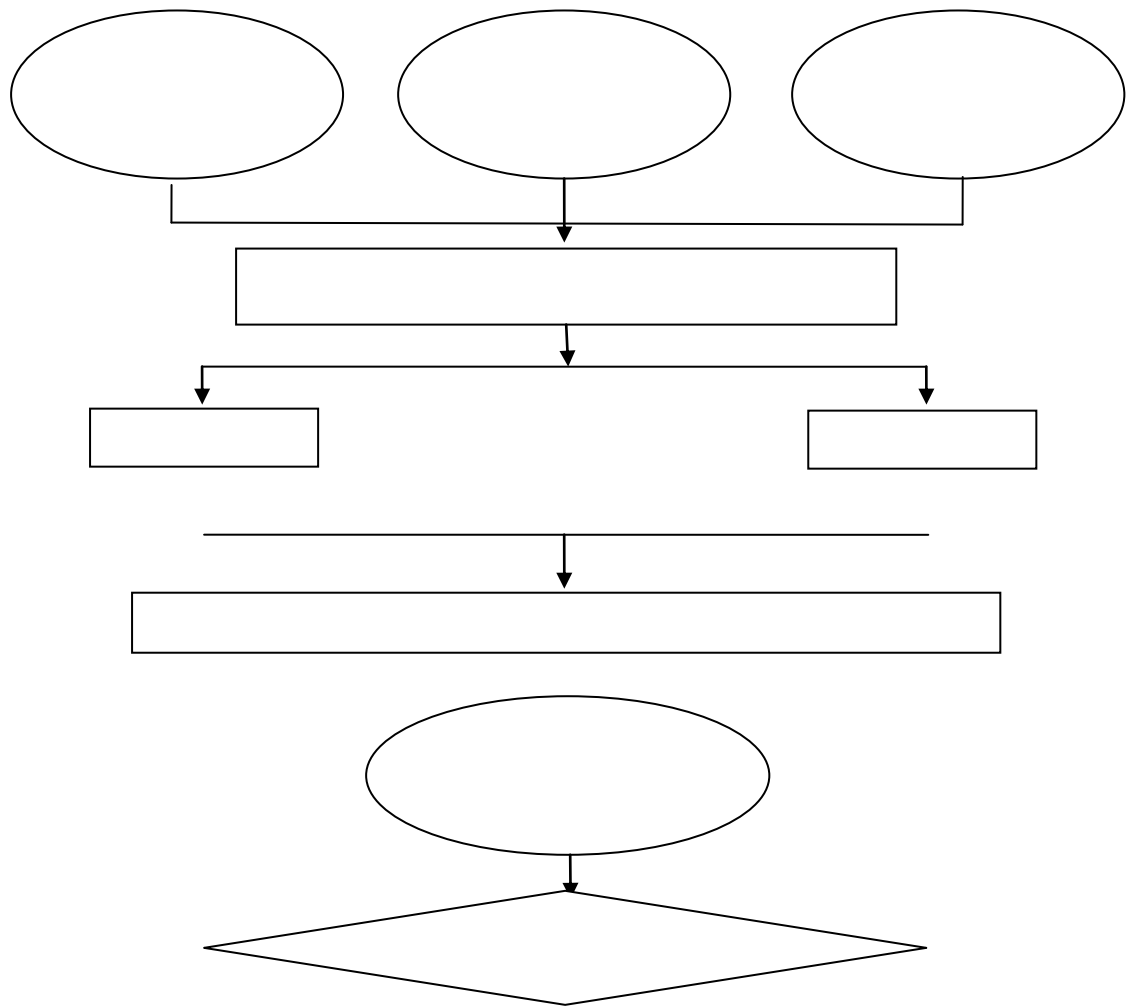

8.2

8.2.1

1

	24	21000	22000	21900
29919			24	

18911229792 5 29792

2

1

67880165	67881105
67881270	
67881471	6881105
67876119	67877947

2

8-2-1

		67837735
		67870861
		67861135
		67885322
		67830220
		67867669
		67820712
		67820689
		87927651
		87855587

3

58266699 120

67870497 120

69243653 120

85231000 120

4

13488769966 \

010-56930400 \ 010-56930615

PONY

13811086995 \ 010-82618116 \

010-82475800

010- 69243360\ 010-69243300

29283 29281

5

北京法美高新中控室	6785 5033	SMIC 附近公司
北京太时芯光中控室	6785 5958	SMIC 附近公司（地泽北街1号）
北京普莱克斯中控室	6785 5660/5219/5662	SMIC 附近公司
北京北方微电子中控室	5784 6999 转 6700	文昌大道8号
和利时	5898 1000 总机	地盛中路2号院
国光高科中控室	6782 6666	西环中路地盛南街1号
爱普特中控室	6787 3701	地盛东路1号爱普特大厦

8.2.2

1

2

3

2015

4

IDLH

1.5m/s

F

IDLH

461.4m

461.4

IDLH

500m

8-2-1

8.2.3

ERC

ERC

8

2

1

2

7

8-2-1

"

"

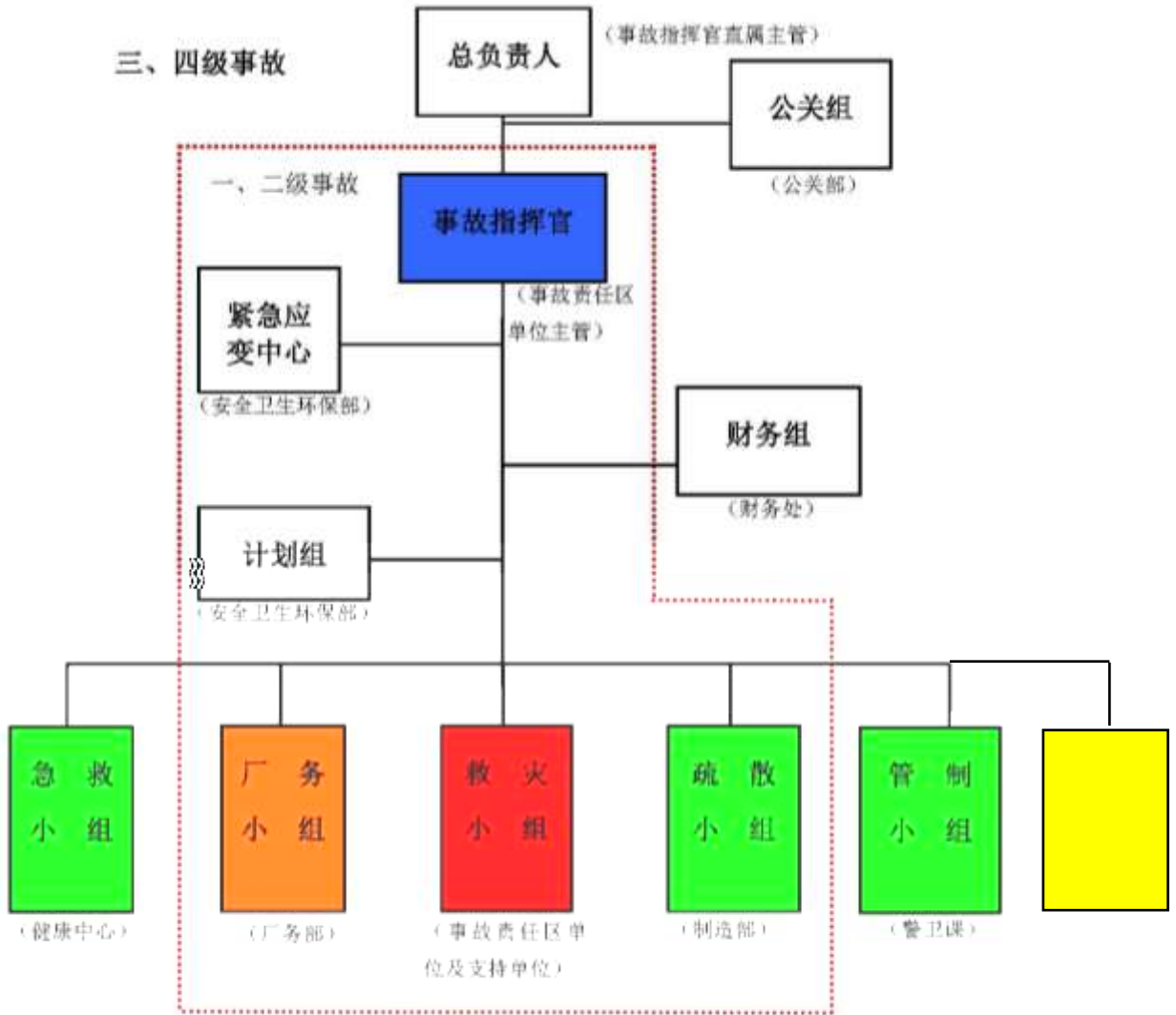

- 应急救援总指挥为公司总经理，并由总负责人、事故指挥官协助开展应急救援工作。
- 虚线框内为一、二级事故应急救援体系；整图为三、四级事故应急救援体系。

8-2-1

1

电力中

2

SMIC Confidential

8.2.4

8.2.4.1

(ERC)

(VESDA, Very Early Smoke
Detector Apparatus) (Fire Alarm System)
ERC ERC
(GMS, Gas Monitor System)
(SCBA, Self Contained Breathing Apparatus)

C A
8-2-2 GMS 8-2-1 10-1
8-2-1

序号	分类	器材名称	数量(可使用)	放置位置	点检频率	备注
1	系统类	录音电话	1	ERC	每月/次	
2	侦测器	SPM	2	ERC	每月/次	每年 PM
3		GP-01	1	ERC	每月/次	每半年校验, 或者更换 Sensor
4		4 in 1	2	ERC	每月/次	每半年校验, 或者更换 Sensor
5		MST	1	ERC	每月/次	每半年更换 Sensor 目前有 C ₄ F ₆ &C ₅ F ₈ &NF ₃ &CH ₂ F ₂ 4 个
6		Compressor	2	Fab2-P1C 1F&PS 2 1F	每月/次	每年 PM
7	设备器材类	紧急应变器材柜	29	FAB: 16 外围: 13	每月/次 每月/次	
8		自给式呼吸器	背架 46 套	ERC: 8 套 外围: 32 套 仓库 6 个背架	每两周/次	背架功能测试: 每三年一次 气瓶水压测试: 每三年一次
			气瓶 68 个			
9		扩音喇叭	大喇叭: 4 个	CCTV: 1 个, ERC: 3	每月/次	放置电池
			小喇叭: 1 个可用	小: ERC: 1		
10		对讲机	31	ERC: 31	每月/次	
11		A 级防护眼测试仪	1	ERC	每月/次	
12		可移动式广场喇叭	1	CCTV	每月/次	充电式
13		手电筒	可充电(黑): 1	可充电(黑): 仓库	每月/次	损耗品
			防爆型(绿): 大: 8	防爆型(绿): 大: ERC		
			防爆型(绿)小: 19	防爆型(绿)小: ERC: 11, 仓库: 8		
			强光大: 7	ERC: 2, 仓库: 5		
			强光小: 1	ERC: 1		
					充电式	

序号	分类	器材名称	数量(可)	位置	有效期	备注
服	31	ERC: 4 仓库: 11 外围: 16	每月/次	有效期为5年	14	A级防
子	30	ERC: 4 仓库: 10 外围: 16	每月/次	无有效期	15	A级防 专用靴
	36	ERC: 12(其中4 套训练用) 外围紧急应变器 材柜: 16套 仓库: 8套	每月/次	无有效期	16	防火服
子	42	ERC: 8 仓库: 12 外围: 22	每月/次	无有效期	17	防酸碱靴
套	36	ERC 仓库: 12 外围紧急应变器 材柜: 24	每月/次	每半年一次绝缘测 试	18	绝缘手
子	36	ERC 仓库: 12 外围紧急应变器 材柜: 24	每月/次	每半年一次绝缘测 试	19	绝缘靴
包	1	ERC	每月/次 套	另: 消防中控室一	20	消防应

8-2-2

CW	ERC-Cabi net
----	--------------

8.2.4.2

01 SMIC(BJ)

(SMIC (BJ) Chemical Poisoning Rescue 0.1.) SMIC (BJ)

0.1. SMIC (BJ) First-Aid Kit Management 0.1 SMIC (BJ)

SMIC (BJ) First-Aid Training Rule SMIC(BJ)

0.1. SMIC (BJ) Emergency First Aid 0.1

5

8.2.2

Ã

序号	物品名称	单位	数量	放置点
1	三角巾	个	1	所有急救箱
2	弹性绷带	卷	3	所有急救箱
3	急救毯	张	1	所有急救箱
4	安全别针	个	4	所有急救箱
5	创可贴	片	24	所有急救箱
6	剪刀	把	1	所有急救箱
7	镊子	把	1	所有急救箱
8	EHS 乳胶手套	双	2 对	所有急救箱
9	纱布片	片	10	所有急救箱
10	医用胶带	卷	1	所有急救箱
11	止血带	根	2	所有急救箱
12	笔式手电筒	个	1	所有急救箱
13	棉签	包	1	所有急救箱
14	消毒药水	瓶	1	所有急救箱
15	折叠担架	副	1	3.5.11.12.13 号急救箱

序号	物品名称	单位	数量	放置点
16	白米醋	袋	1	3.6.11 号急救箱
17	硼酸洗液	瓶	1	3.6.11 号急救箱
18	100ml 生理盐水	瓶	1	3.6.11 号急救箱

8-2-4

1	1	B01 3F
2	2	FAB2-P1-B 2F 19/J
3	3	FAB2-P1-A 1F
4	4	FAB2-P1-B 3F 17/J
5	5	CUB 1F 4#
6	6	CW 1F
7	7	FAB2-P1-A 2F 15/J
8	8	FAB2-P1-A 3F 15/J
9	9	FAB2-P1-C 2F 14/G
10	10	FAB2-P1-C 3F 10/G
11	11	FAB2-P1-B 1F
12	12	2 ERC
13	13	3 ERC

8.2.5

1

—
19 MDA — HCl DCS BCl₃ WF₆ SiF₄ BF₃
NO C₁F₃ NH₃ Cl₂ HBr SiH₄ PH₃ AsH₃ B₂H₆O₃ F₂/Kr/Ne NO₂ F₂ HF MST
— C₄F₆ C₅F₈ NF₃ CH₃F —
O₂ CO H₂S Flammable

2

pH COD

VOC

8.2.6

SMI C(BJ)

() SMI C SMI C

SMI C SMI C SMI C

SMI C(BJ) SMI C(BJ) ESH

SMI C(BJ) SMI C(BJ) ESH

I SMI C SMI C SMI C

SMI C ERC SMI C

SMI C

01 SMI C(BJ) 0.1 SMI C (BJ)

SMI C (BJ) First-Aid Training Rule SMI C(BJ)

0.1

ERC
SCBA

8.2.7

500

PPE SCBA

(HJ589-2010)

67855000-21000

22000 21900

1

(HJ589-2010)

2

(HJ589-2010)

1

1min

50m

50mm

2

pH COD

3

570m

500m

(),

10m 50m 100m 200m 500m 1000m 2000
pH COD

5

-

0.2mg/m³

a

b

c

9-1-1

		1 /	
		1 /	
		1 /	
		1 /	pH COD
		1 /	pH COD

7

13488769966 \

010-56930400 \ 010-56930615

PONY

13811086995 \ 010-82618116 \

010-82475800

010- 69243360\ 010-69243300

29283 29281

10.1

1

2

3

4

5

10.2

1

2

3

10.3

1

2

3

4

5

6

7

8

9

10

10. 4

10. 4. 1

1

2

3

4

5

6

10. 4. 2

10. 4. 3

1

2

3

11.1

1

1

2

1 2 1

11.2

2018

2015-2018

11.2-1

11-2-1 2015-2018

2015	59		1. 2. 3.	1. 2 2. 1 3. 1
2016	57			
2017	54			

1

2

1

2

3

4

5 5km

6

7

8

9

10-1 GMS

10-2